

Orthopaedic Instruments



INDEX

<u>PARTICULARS</u>	<u>PAGE</u>
1) ORTHOPEDIC DRESSING – PLASTER INSTRUMENTS	01-03
2) AMPUTATION SAW – GIGLI SAW	04-05
3) REAMERS – AWLS – BONE HOOKS	06-07
4) ORTHOPEDIC HAND BONE DRILLS & ACCESSORIES	08-11
5) BONE HOLDING CLAMPS – TRACTION BARS	12-13
6) VISE GRIPS – NOSE PLIERS – SLAP HAMMERS	14-15
7) NOSE PLIERS – PULLING FORCEPS – WIRE CUTTERS	16-18 19-20
8) PLIERS – BENDERS – ROD INSTRUMENTS	21-23
9) WIRE INSTRUMENTS – EXTENSION BOWS	24-25
10) RING CUTTERS – LEAD HANDS – BIPOSY TOOLS	26
11) BONE TEMPERS – IMPACTORS - PACKERS	27-30
12) BONE RASPS – FILES	31-37
13) BONE LEVERS – RETRACTORS	38-43
14) CHISELS – OSTEOTOMES – GOUGES	44-49
15) BONE CURETTES	50-54
16) PERIOSTEAL ELEVATORS – DISSECTORS	55-58
17) ORTHOPEDIC MALLETS & ELEVATORS SPINAL S/S & SPINAL	59-62 63-64
18) TENDON INSTRUMENTS	65-72
19) PELVIC REDUCTION FORCEPS	73
20) BONE HOLDING FORCEPS	74-77
21) REPOSITION – CARTILAGE FORCEPS	78-88
22) BONE CUTTING FORCEPS	89-90
23) BONE RONGEURS – NIBBLERS	91-92
24) RIB SHEARS	93
25) LAMINA SPREADERS – RETRACTORS	94-95
26) CALCANEAL LAMBARDI SPREADERS	96
27) COMPRESSORS - DISTRACTORS	97-100
28) ROD BENDERS	101-102
29) CARBIDE WIRE – PIN CUTTING PLIERS	103-115
30) CARBIDE INSERTED SURGICAL SCISSORS	
31) INSTRUMENTS FOR TRUATOMY	

ORTHOPEDIC DRESSING – PLASTER INSTRUMENTS

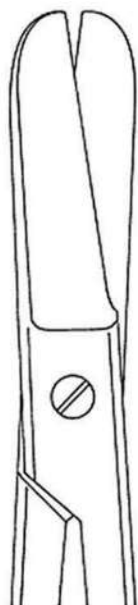

RD-03-0300

Lorenz Bandage Scissors
Heavy Pattern 23 cm / 9"



Also available
in 18.5 cm / 7 1/4"
& 20 cm / 8"



RD-03-0301

Lister Bandage Scissors
14.5 cm / 5 3/4"

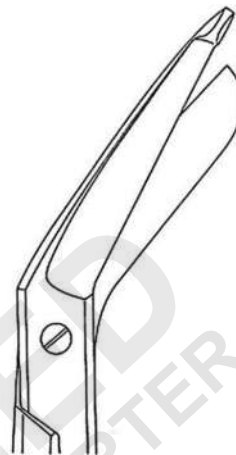

RD-03-0302

Bergmann Plaster Shears
Heavy Pattern 23.5 cm / 9"
114"



RD-03-0303

Esmarch Plaster Shears
Heavy Pattern, Short Blades
20 cm / 8"



RD-03-0304

Bandage Scissors
16cm / 6 1/4" Black Plastic Rings

Also available
in 18cm / 7 1/2"

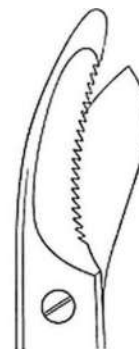

RD-03-0305

Brun's Plaster Scissors 24 cm
9 1/2" One Serrated Cutting Edge



ORTHOPEDIC DRESSING - PLASTER INSTRUMENTS



RD-03-0306

Stille-Martin Plaster Shears
23 cm / 9"



RD-03-0307

Engel Plaster Saw 15.5 cm / 6"



RD-03-0308A

Engel Plaster Saw 15.5 cm / 6"



RD-03-0308B

Bergmann Plaster Saw 18 cm / 7"

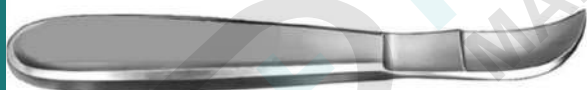

RD-03-0309

Reiner Plaster Knife 18 cm / 7"



RD-03-0310

Hopkins Plaster Knife 20 cm / 8"



RD-03-0311

Esmarch Plaster Knife 18 cm / 7"



with wooden handle

RD-03-0312

Martin Plaster Knife 21 cm / 8 1/4"

ORTHOPEDIC DRESSING – PLASTER INSTRUMENTS

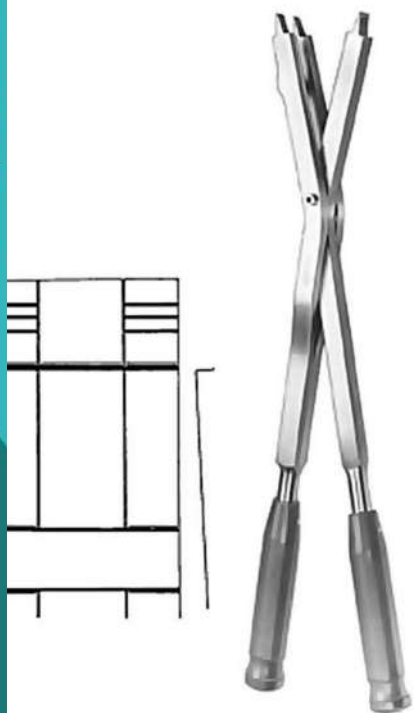

RD-03-0313

Hermann Plaster Spreader
48 cm / 19" Heavy Pattern

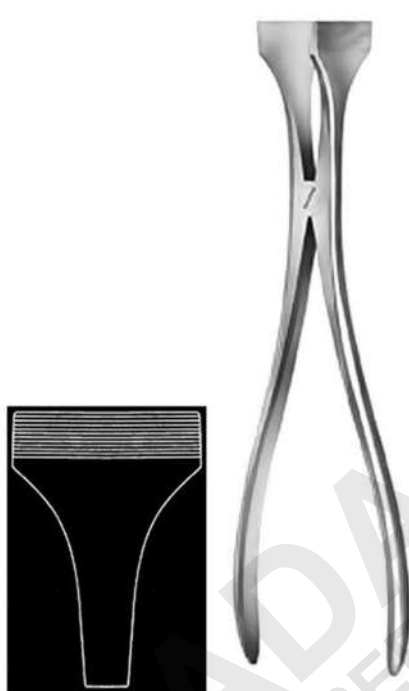

RD-03-0314

Hennig Plaster Spreader
28 cm / 11"



RD-03-0315

Hennig Plaster Spreader
30 cm / 12"



RD-03-0316 Beeson Plaster Spreader 1.5 in Blade 30 x 12"

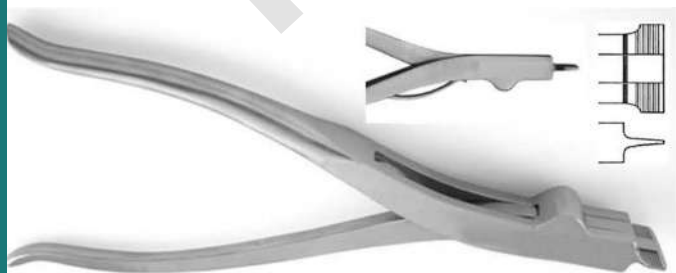

RD-03-0317 Walton Plaster Spreader w/Spring 3 Prongs 23 cm / 9"

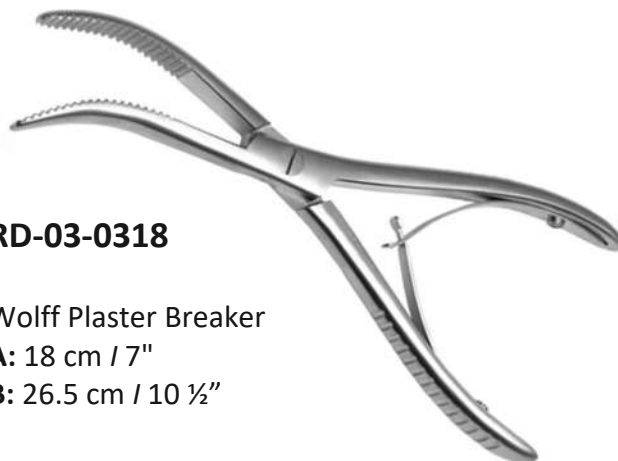

RD-03-0318

Wolff Plaster Breaker
A: 18 cm / 7"
B: 26.5 cm / 10 1/2"

AMPUTATION SAW – GIGLI SAW

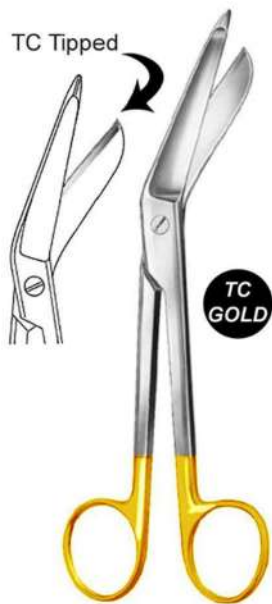

RD-03-0319

Master Bandage Scissors TC
18 cm / 7" cm / 13 3/4"



RD-03-0320

Bruns Plaster Scissors
24 cm / 9 1/2"



RD-03-0321

Charriere Amputation Saw 35 cm / 13 3/4"

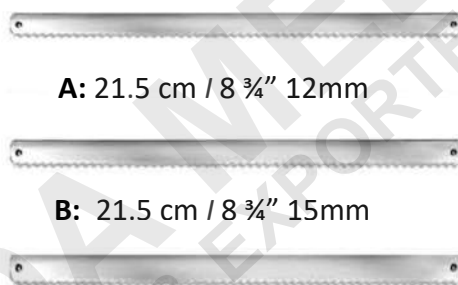

Spare Saw Blades

A: 21.5 cm / 8 3/4" 12mm

B: 21.5 cm / 8 3/4" 15mm

C: 21.5 cm / 8 3/4" 18mm wide



RD-03-0322

BIER Amputation Saw 40.5 cm / 16"



A: 27 cm / 10 3/4" 4 mm wide



B: 27 cm / 10 3/4" 6 mm wide



C: 27 cm / 10 3/4" 8 mm wide



RD-03-0323

Langenbeck Amputation Saw 24.5 cm / 9 3/4"



RD-03-0324 Satterlee Amputation Saw

29 cm / 11 1/2"



RD-03-0325 Charriere Amputation Saw 27 cm / 10 1/2"



RD-03-0326 Satterlee Amputation Saw 23 cm / 9"

AMPUTATION SAW – GIGLI SAW

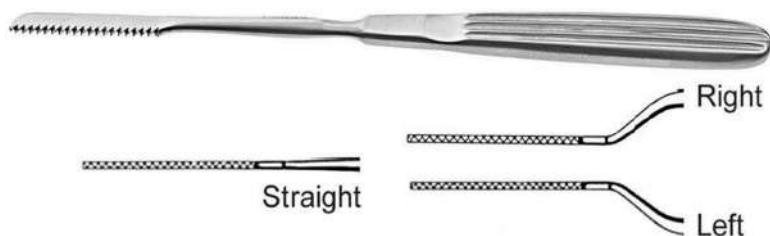

RD-03-0327 Joseph Amputation Saw 18 cm / 7"

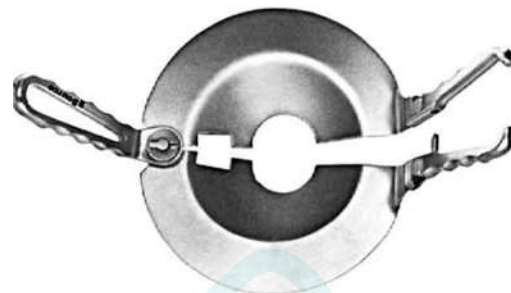

RD-03-0328

Percy Amputation Shield 30 cm / 12"



RD-03-000

- A: Gigli Saw 30cm
- B: Gigli Saw 50cm
- C: Tyler Gigli Saw (Large Cut) 30cm
- D: Tyler Gigli Saw (Large Cut) 30cm



Gigli Saw Handles SOLID

RD-03-001 Gigli Sold in Pair

RD-03-002 Gigli Sold in Pair



Gigli Saw Handles SOLID

RD-03-003
Gigli Sold in Pair

RD-03-004
Gigli Sold in Pair



RD-03-005 BAILEY GIGLI SAW GUIDE 30 CM



RD-03-006 POPPEN GIGLI SAW GUIDE 28 CM



REAMERS - AWLS - BONE HOOKS



RD-03-0329
Reamer
13.5cm / 5 1/4"



RD-03-0330
Perthes Reamer
18 cm / 7"



RD-03-0331
Perthes Reamer
21.5 cm / 8 1/2"

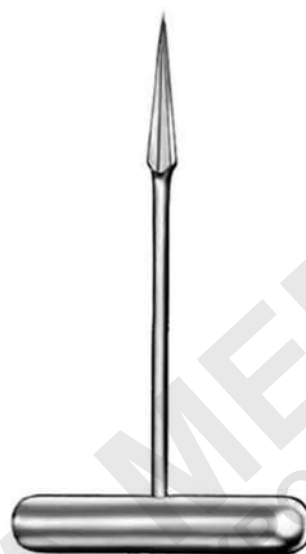

RD-03-0332
Reamer One concave side
14 cm / 5 1/2"



RD-03-0333
Glenoid Punch
20 cm / 8"

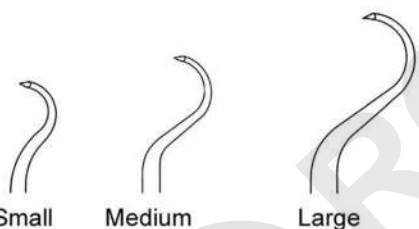

RD-03-0334
Shoulder Percussion Awl A: 21.5cm / 8 1/2" B: 23.5cm / 9 1/4"



A: 20cm / 8"
19X27mm
Sharp

B: 23cm / 9"
15X20mm
Blunt

C: 23cm / 9"
15X20mm
Sharp

C: 25cm / 9 3/4"
15X20mm
Sharp

RD-03-0335 Volkman Bone Hook

REAMERS - AWLS - BONE HOOKS



RD-03-0336

Kuntscher Diamond Awl 28 cm / 11"

Pointed

RD-03-0337
Rush Awl / Reamer

- A: 19 cm / 7 1/2" 2.5mm
- B: 21 cm / 8 1/4" 3mm
- C: 21 cm / 8 1/2" 5mm
- D: 26 cm / 10 1/2" 6mm

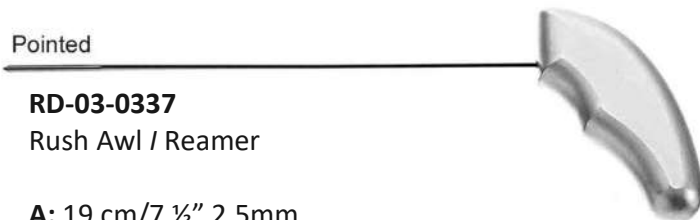

RD-03-0338

Bone Hook 23 cm / 9"

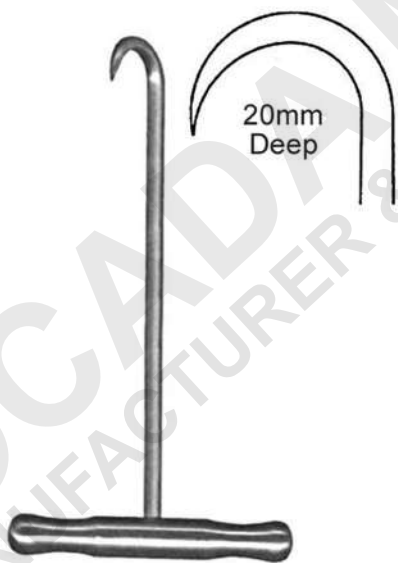

RD-03-0339

Bone Hook T Handle 20 cm / 8"



RD-03-0340

Bone Hook T Fiber Handle 14cm / 5 5/8"

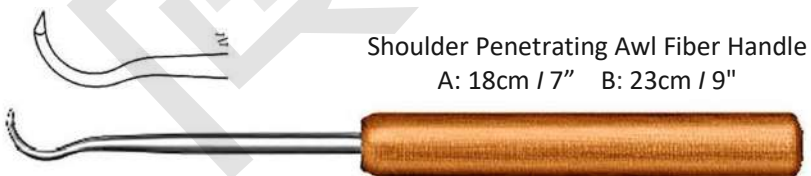

Shoulder Penetrating Awl Fiber Handle
A: 18cm / 7" B: 23cm / 9"

RD-03-0341



RD-03-0342

Pointed Awl Fiber Handle 25cm / 10"

ORTHOPEDIC HAND BONE DRILLS -ACC

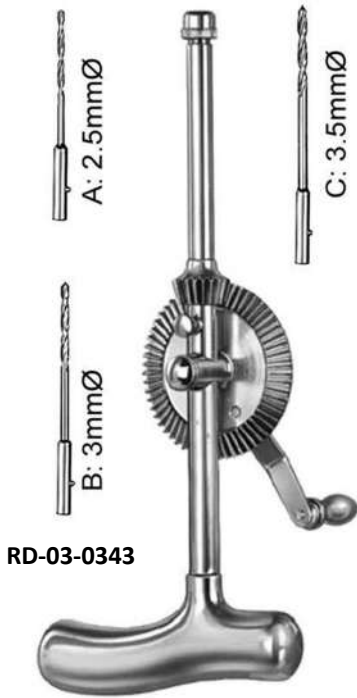

RD-03-0343

Stille-Sherman Hand Drill
24 cm / 9 1/2" with 3 twist drills

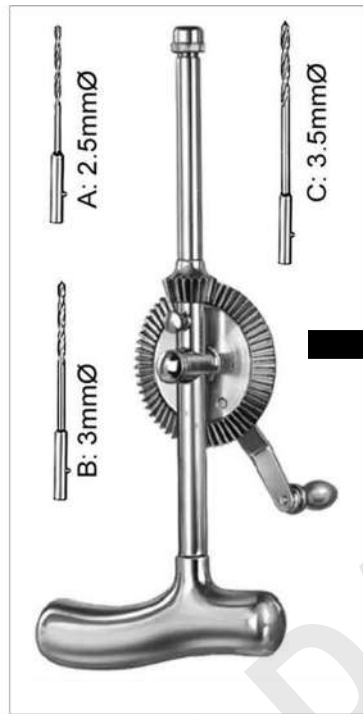

RD-03-0344

Stille Hand Drill 20.5 cm / 8" w / 9 Twist Drills

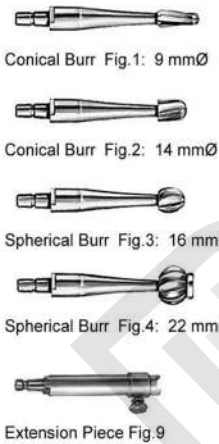
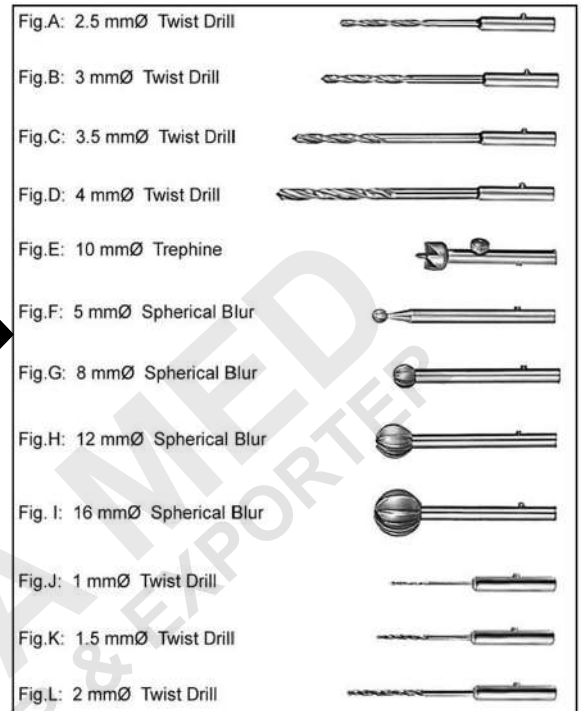

RD-03-0345

Hudson Hand Drill
28 cm / 11"
Complete with burrs Fig #. 1 - 4
& additional price for additional
accessories

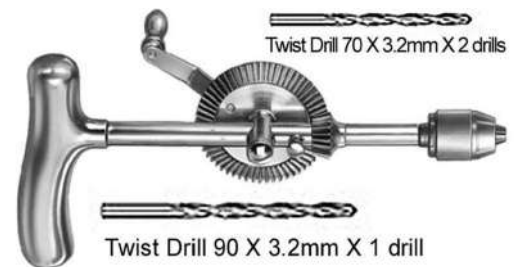
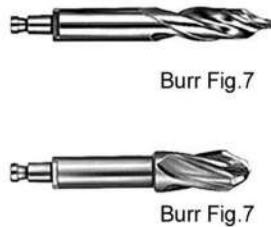
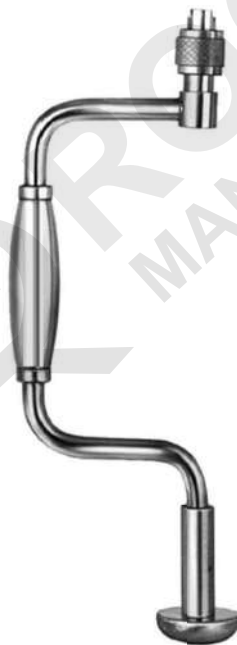

RD-03-0346 Moore Hand Drill
Complete with a set of 3 twist drills

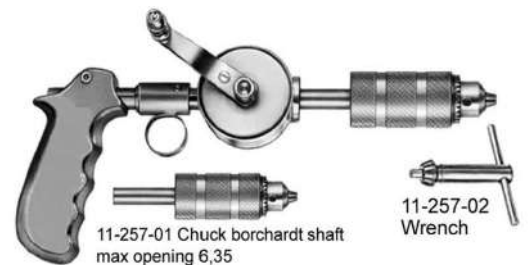

RD-03-0347

Martin Hand Drill with Chuck & Wrench

ORTHOPEDIC HAND BONE DRILLS -ACC



RD-03-0348
Bunnell Hand Drill
16cm / 6-1/4"

Longitudinally Bored with 3-Jaw-Chuek
Light Metal Housing opening up to 4mm



RD-03-0349
Bunnell Hand Drill
16cm / 6-1/4"

Twin Shade Powder Coated Longitudinally
bored with 3-Jaw-Chuek light metal
housing opening up to 4mm



RD-03-0350
Ralk Hand Drill

Light Metal Housing
Literally Angled Handle with 3-Jaw-Chuek
and key, opening up to 6,35mm



RD-03-0351

HAND DRILL
All Covered Polished / Dull or Coated.
Drills Holder at Bottom.

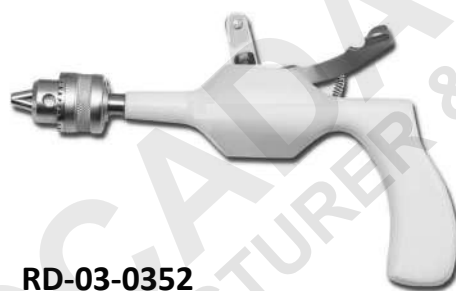

RD-03-0352

Hand Drill
All Covered Light Weight / Polished /
Dull or Coated. Key Holder and Self
Retaining Locking Mechanism



Box for Hand Drills
Outside Artificial Leather
/ inside Jumbo Foam



RD-03-0353

Hand Drill
Polished / Dull or Coated. Operated
Horizontally and Vertically



RD-03-0354

Hand Drill
Polished / Dull or Coated.
All Covered

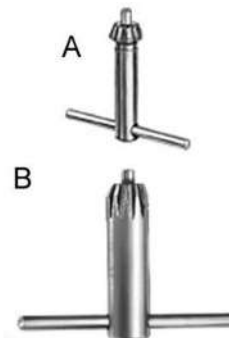

All Hand Drills
Provided with Keys

ORTHOPEDIC HAND BONE DRILLS -ACC



RD-03-0355

Hand Drill
Polished / Dull
Or Coated.
Open Housing



RD-03-0356

Hand Drill
Polished / Dull
Or Coated.
Open Housing



RD-03-0357

Hand Drill
Polished / Dull
Or Coated.
Semi Closed Housing



RD-03-0358

Vickers Easidriver 14 Cm / 5 1/2"



RD-03-0359

14 cm / 5 1/2"
Handle W/ Chuck Longitudinally
Bored Accommodating up to 3,95mm



RD-03-0360

Handle with chuck T-Shaped



RD-03-0361

Fiber T-Handle Key



RD-03-0362

Key



RD-03-0363

Key

ORTHOPEDIC DRILL BITS – BURS - TREPHINES



RD-03-01

5mm Borchardt Shaft Twist Drill, Long Working End

A: 2.0mm B: 2.5mm C: 3.0mm D: 3.2mm E: 3.5mm F: 4.0mm G: 5.0mm H: 6.0mm I: 7.0mm



RD-03-02

5mm Borchardt Shaft Twist Drill

A: 1.0mm B: 1.5mm C: 1.8mm D: 2.0mm E: 2.2mm F: 2.5mm G: 2.8mm H: 3.0mm I: 3.2mm J: 3.5mm K: 4.0mm L: 5.0mm



RD-03-03

5mm Borchardt Shaft Flat Trepine

A: 1.8mm B: 2.0mm C: 2.2mm D: 2.5mm E: 3.0mm F: 3.5mm G: 4.0mm H: 5.0mm



RD-03-04

5mm Borchardt Shaft Spherical Burr

A: 3.0mm B: 4.0mm



RD-03-05

5mm Borchardt Shaft Spherical Burr

A: 3.0mm B: 5.0mm

Long 5mm Borchardt Shaft



RD-03-06 Doyen
Spherical Burr

A: 4mm B: 6mm C: 8mm D: 10mm E: 12mm F: 14mm G: 16mm

Short 5mm Borchardt Shaft

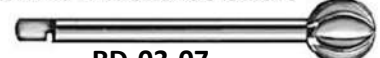

RD-03-07

Doyen Spherical Burr

A: 4mm B: 6mm C: 8mm D: 10mm E: 12mm F: 14mm G: 16mm

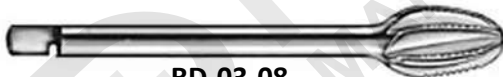

RD-03-08

Doyen Conical Burr
Coarse Spacing 12mm Dia



RD-03-09

Doyen Conical Burr
Fine Spacing A: 8mm / B: 10 mm



RD-03-10

Doyen Cylindrical Burr
Coarse Spacing A: 12mm / B: 15mm



RD-03-11

Albee Burr Oval Coarse Spacing
A: 8mm / B: 10 mm / C: 12 mm



RD-03-12

Albee Burr Pointed 7 mm



RD-03-13

Borchardt Burr Oval Coarse Spacing 13mm



RD-03-14

Flat Burr Short Borchardt Shaft 25mm



RD-03-15

Toti Trepine Short Borchardt Shaft 8mm

BONE HOLDING CLAMPS – TRACTION BAR

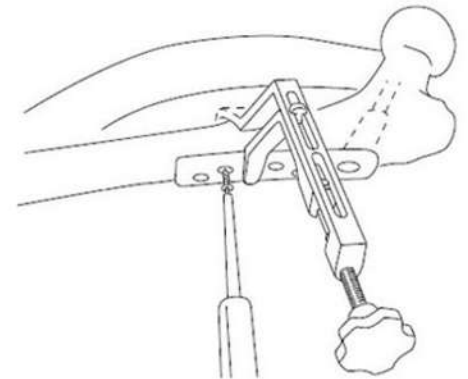
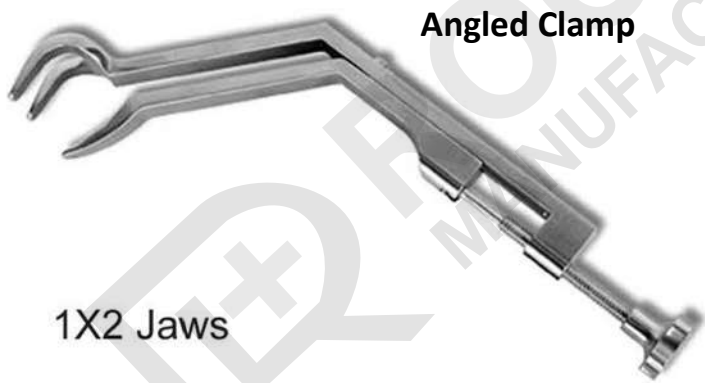
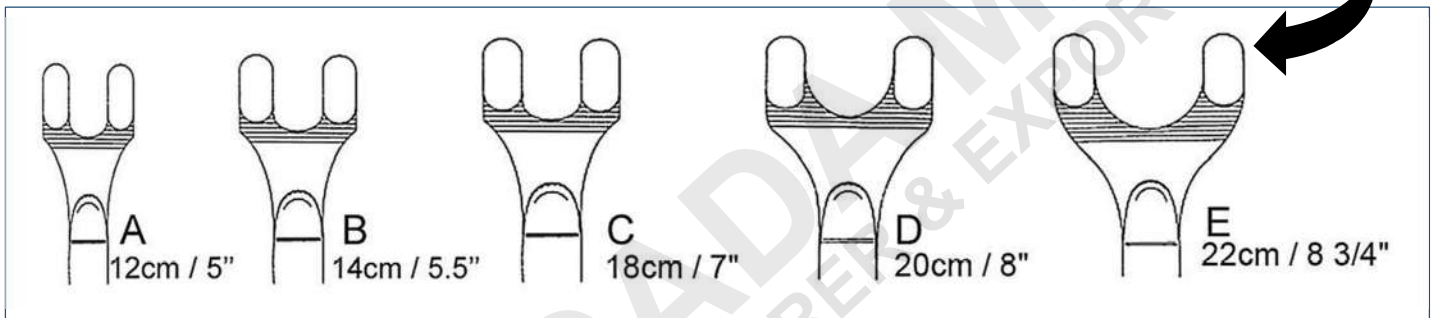
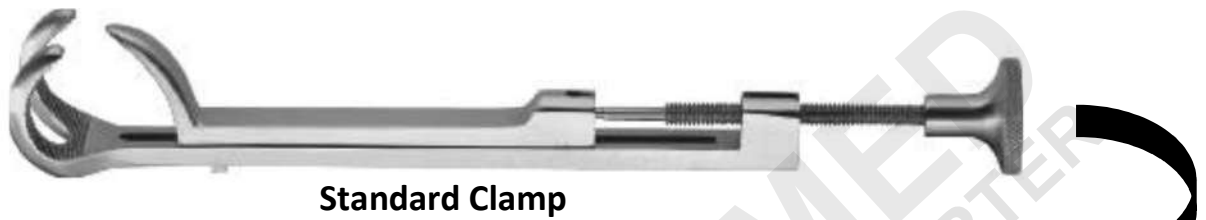

RD-03-0365 Gerster-Lowman Bone Holding Clamp

BONE HOLDING CLAMPS – TRACTION BAR



RD-03-0366 Gerster Traction bar 15 cm / 6"

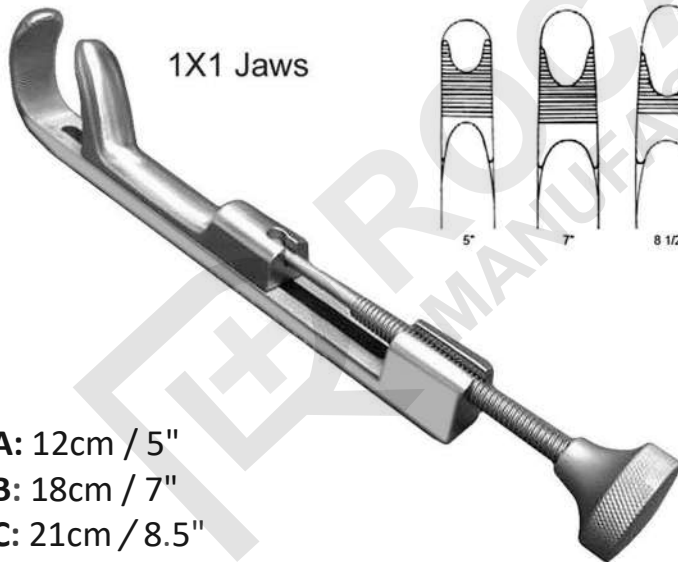

1X1 Jaws

- A: 12cm / 5"
- B: 18cm / 7"
- C: 21cm / 8.5"

RD-03-0367
Gerster-Lowman Bone Holding Clamp

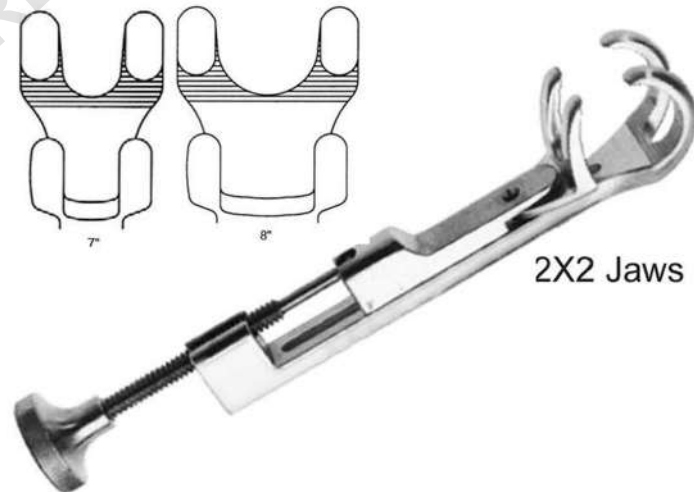

2X2 Jaws

- A: 18cm / 7"
- B: 20cm / 8"

RD-03-0368
Gerster-Lowman Bone Holding Clamp

WISE GRIPS – NOSE PLIERS – SLAP HAMMERS [ALL MADE OF STAINLESS STEEL]



RD-03-0369
Vise Grip Locking Plier 23 cm / 9"



RD-03-0372
Needle Nose Locking Plier 30 cm / 12"



RD-03-0370
Vise Grip Locking Plier 20.5 cm / 8"



RD-03-0373
Needle Nose Locking Plier 25.5 cm / 10"



RD-03-0371
Vise Grip Locking Plier 18 cm / 7"



RD-03-0374
Needle Nose Locking Plier 22 cm / 8.5"



RD-03-0375
Flat Nose Plier 18.5 cm / 7 1/4" Parallel Grip SS



RD-03-0377
Long Nose Plier 22 cm / 8 1/4"



Max 1.6mm Cutting Capacity

RD-03-0376
Flat Nose Plier-Cutter 18.5 cm / 7 1/4" Parallel Grip SS



RD-03-0378
Vise Grip 20.5 cm / 8" Stainless Steel

WISE GRIPS – NOSE PLIERS – SLAP HAMMERS [ALL MADE OF STAINLESS STEEL]



RD-03-0379
Regular Jaw Locking Plier
A: 18 cm / 7" B: 20 cm / 8" C: 23 cm / 9"



RD-03-0380
Needle Nose Locking Plier
A: 22 cm / 8.5" B: 25.5 cm / 10" C: 30 cm / 12"



RD-03-0381
SLAP HAMMER w/ Threaded Shaft Head



RD-03-0382
SLAP HAMMER w/ Hexa Shaft Head



RD-03-0383
Combi-Fiat Nose Pliers 15 cm / 6"
For Bending & Cutting



RD-03-0385
Flat Nose Plier 13.5 cm / 5 ¼"



RD-03-0384
Round / Flat Nose Pliers 18 cm / 7"



RD-03-0386
Hackstock Flat Nose Pliers 16 cm / 6 ¼"

NOSE PLIERS – PULLING FORCEPS – WIRE CUTTERS

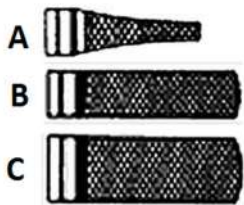

RD-03-0387
Flat Nose Pliers 18 cm / 7" Parallel Grip



RD-03-0388
Flat Nose Pliers 17 cm / 6 ¾" with crosswise groove



RD-03-0389
Flat Nose Pliers 17.5 cm / 7"



RD-03-0390
Flat Nose Pliers Pointed 19.5 cm / 7 ¾"



RD-03-0391
Platypus Nail Pulling Forceps 15.5 cm / 6 ¼"

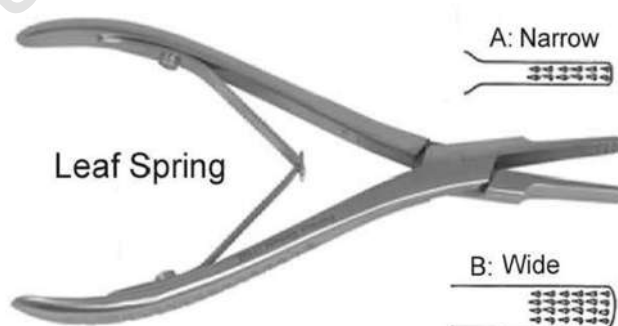

RD-03-0392
Platypus Nail Pulling Forceps 15.5 cm / 6 ¼"



RD-03-0393
Round Nose Pliers 15.5 cm / 6 ¼"

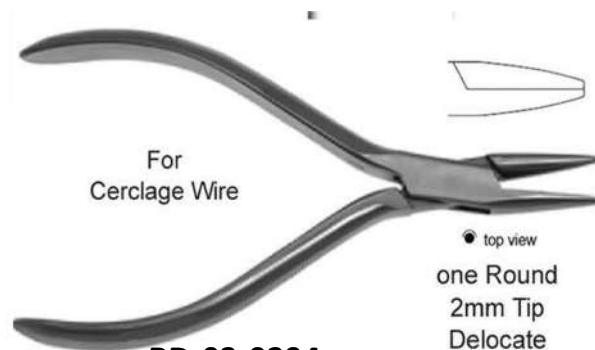

RD-03-0394
Needle Nose Pliers 15.5 cm / 6 ¼"

NOSE PLIERS – PULLING FORCEPS – WIRE CUTTERS

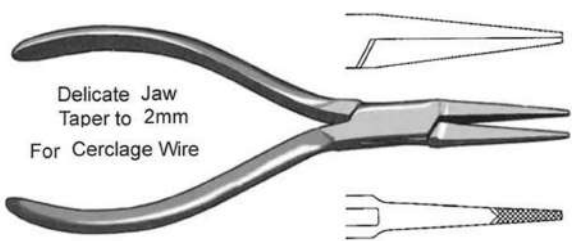

Delicate Jaw
Taper to 2mm
For Cerclage Wire

RD-03-0395
Flat Nose Pliers 15 cm / 6"

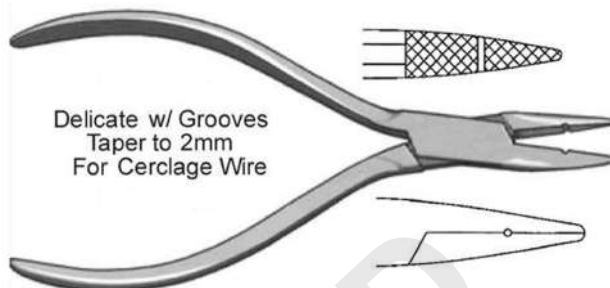

Delicate w/ Grooves
Taper to 2mm
For Cerclage Wire

RD-03-0396
Needle Nose Pliers 13.5 cm / 5 1/4"

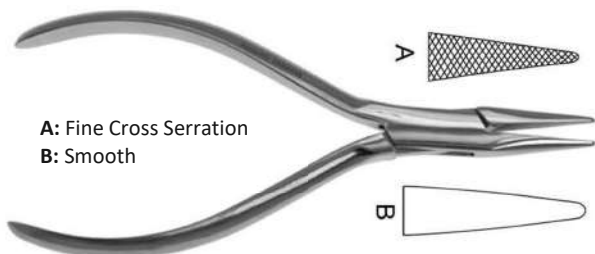

A: Fine Cross Serration
B: Smooth

RD-03-0397
Needle Nose Pliers Taper to 2mm Tip 14 cm / 5 1/2"



Soft wires up to 2.4mm
Hard wires up to 1.8mm

RD-03-0398
Wire Cutting Pliers 18.5 cm / 7 1/4"



RD-03-0399
Martin "Diamant" 16cm / 6 1/4"



Delicate w/ Grooves
Taper to 2mm
For Cerclage Wire

RD-03-0400
Circlage Pliers / Cutter 14 cm / 5 1/2"

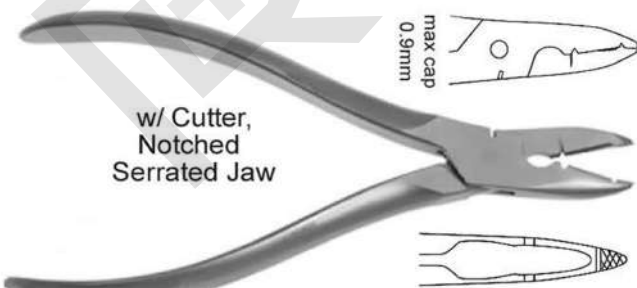

w/ Cutter,
Notched
Serrated Jaw

RD-03-0401
Wire Bending Pliers 20 cm / 8"

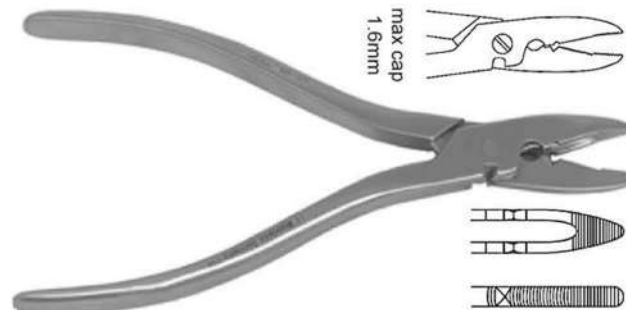

max cap
1.6mm

RD-03-0402
Wire Bending Pliers 15 cm / 6"

NOSE PLIERS – PULLING FORCECEPS – WIRE CUTTERS



RD-03-0403
Wire Bending Pliers TC 20 cm / 8"

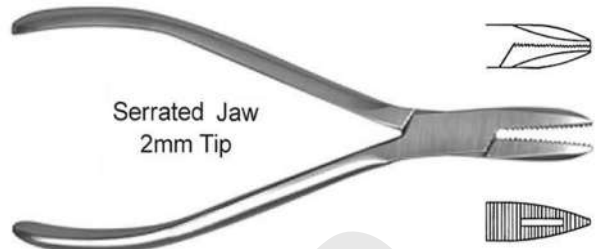

RD-03-0404
Needle Nose Pliers 15 cm / 6"

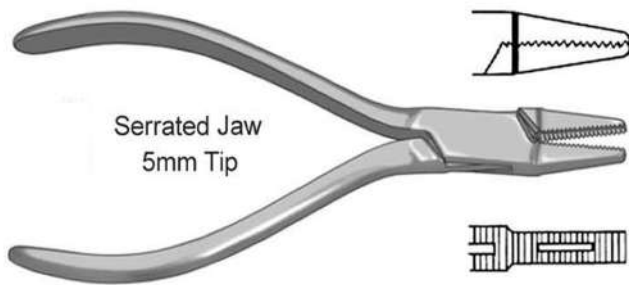

RD-03-0405
Flat Nose Pliers 14 cm / 5 1/2"

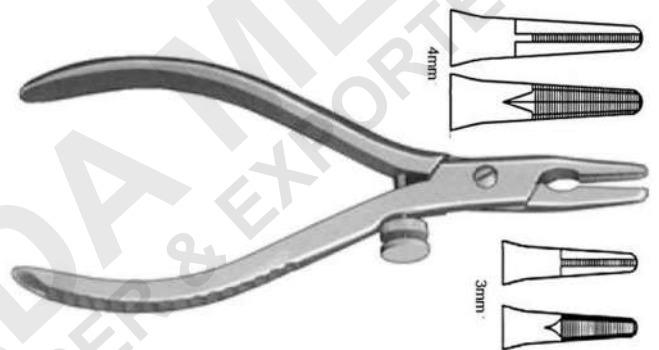

RD-03-0406
K-Wire Pliers **A:** 13 cm / 5" **B:** 17.5 cm / 7"

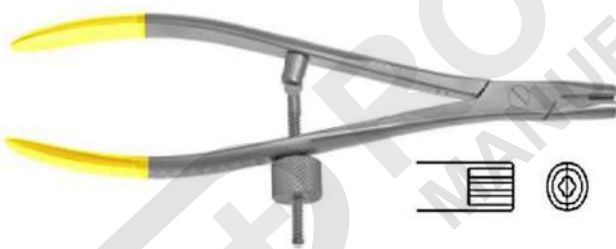

RD-03-0407
Screw/Pin Removing Pliers 19 cm / 7 1/2"

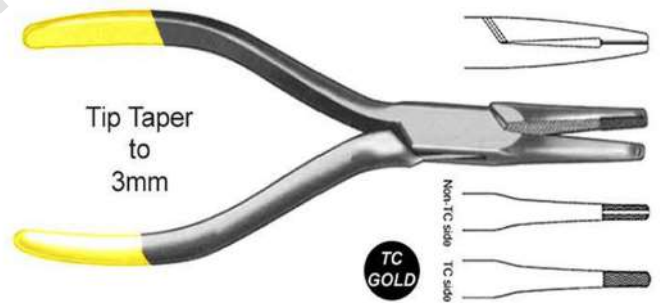

RD-03-0408
Pin Puller Grips Small Pins 14 cm / 5 1/2"

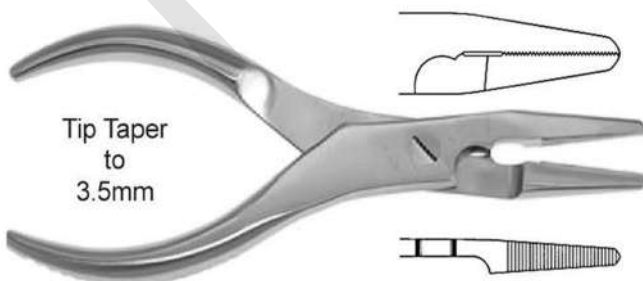

RD-03-0409
Flat Nose Pliers w/ Cutter for Cerclage Wire 16 cm / 6 1/2"



RD-03-0410
19 cm / 7 1/2" Narrow Nose Pliers Heavy Jaws for Pulling Wire / Pins

PLIERS – BENDERS – ROD INSTRUMENTS

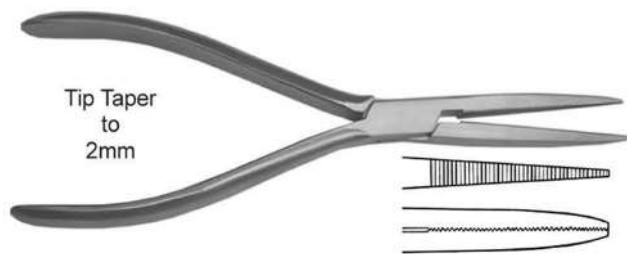

RD-03-0411
Long Jaw Pliers 2inch Long Jaw Delicate 17.5 cm / 7"

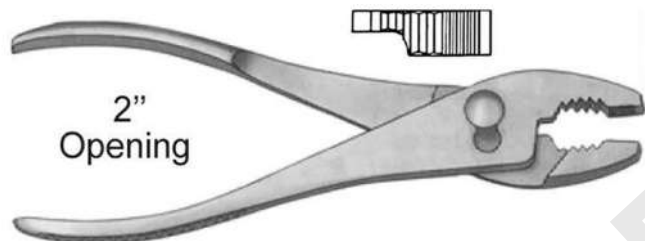

RD-03-0413
Slip Joint Pliers 20 cm / 8"

A: 17.5 cm / 7" Needle Nose 2" Jaw
B: 16 cm / 6 1/2" Square 7mm Jaw
C: 18 cm / 7" Tape to 2mm Tip

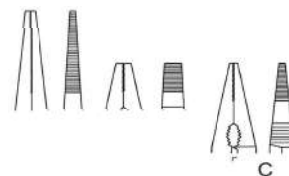

RD-03-0412
UNIVERSAL Pliers
Serrated w/ Heavy duty Spring and Cutting Edge
Max Cutting Cap: 1.1 mm



RD-03-0414
Lineman Pliers 21 cm / 8 1/2"

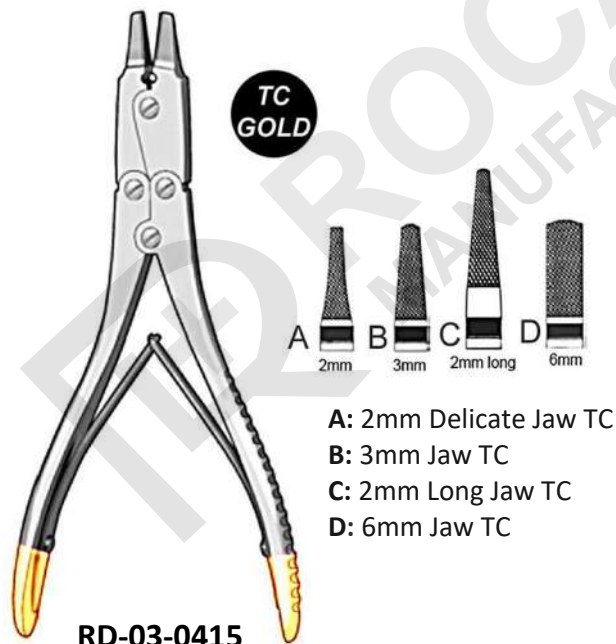

RD-03-0415
Double Action Wire Extraction Plier
18 cm / 7"

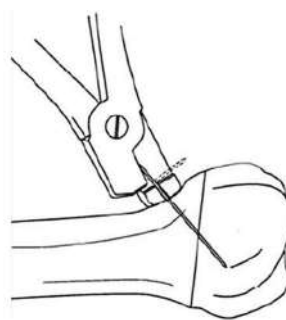

RD-03-0416
Gratloch Wire Bender
19 cm / 7 1/2"



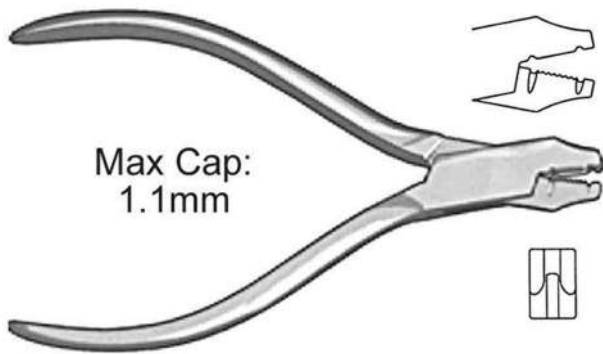

Max Cap:
1.1mm

RD-03-0417

K-Wire / Plate Bender 13.5cm / 5"



Max Cap:
1.6mm

RD-03-0418

K-Wire / Plate Bender 14.5 cm / 5 ½"

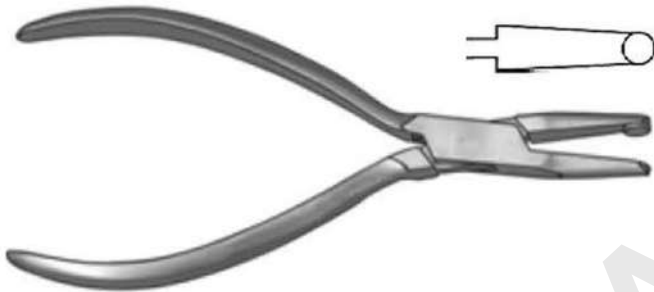

RD-03-0419

Mini Plate Bending Pliers 13.5 cm / 5"

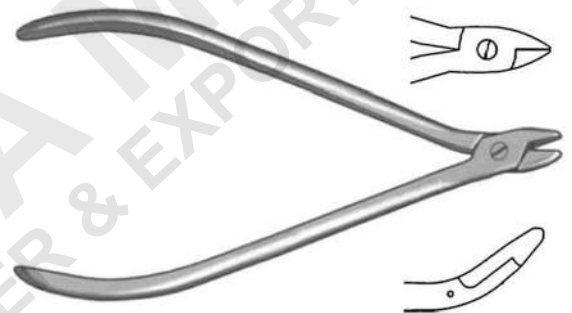

RD-03-0420

Plate Bending Pliers 14.5 cm / 5 ½"

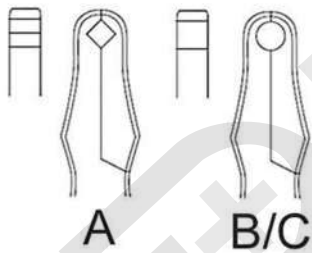

- A: 5.5mm Rods Prism
- B: 5.5mm Rods
- C: 6.35mm Rods



RD-03-0421

Rod Holder STR 25 cm / 10"

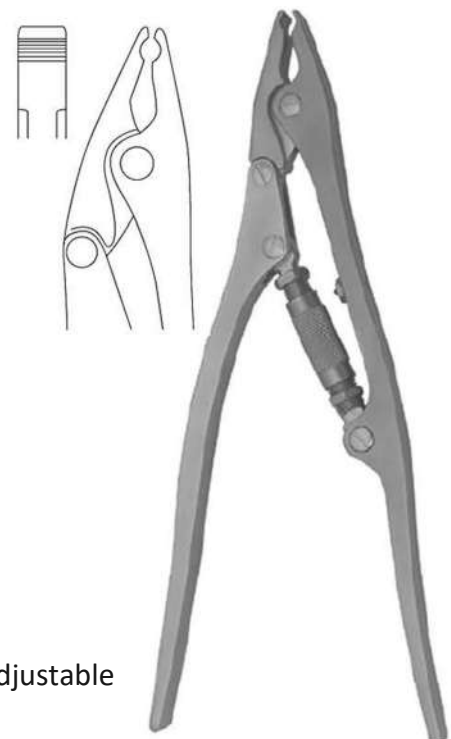

RD-03-0422

Rod Gripper Adjustable
21 cm / 8 ½"

WIRE INSTRUMENTS – EXTENSION BOWS

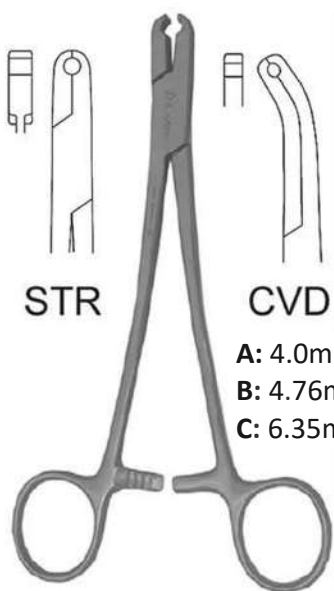

STR

CVD

- A: 4.0mm Rod
- B: 4.76mm Rod
- C: 6.35mm Rod

RD-03-0423

Rod Holder 18 cm / 7 ¼"



RD-03-0424

Wire Pulling Forceps 16 cm / 6 ½"

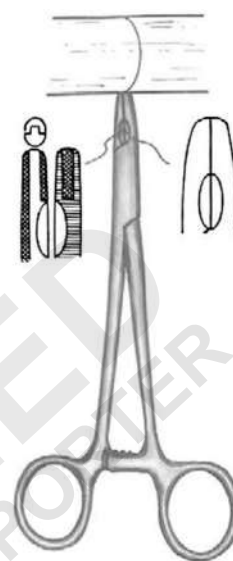

RD-03-0425

Wire Twister / Tightner 16cm / 6 ¼"



RD-03-0426

Loute Wire Tightener 21 cm / 8 ¼"



RD-03-0427

Wire Tightener 12 cm / 4 ¾"



RD-03-0428

Wire Tightener w / T Handle
11.5 cm / 4 ½"

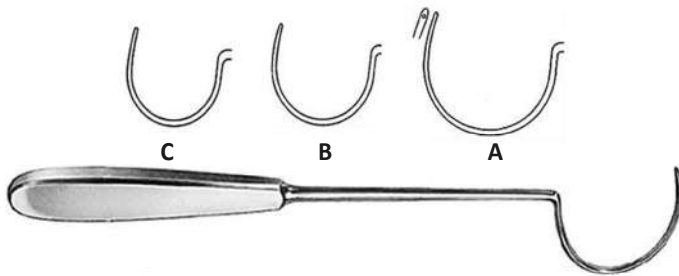

A: 31 cm / 12 1/4"
B: 29 cm / 11 1/2"
C: 28 cm / 11"

RD-03-0429
Demel Wire Guide

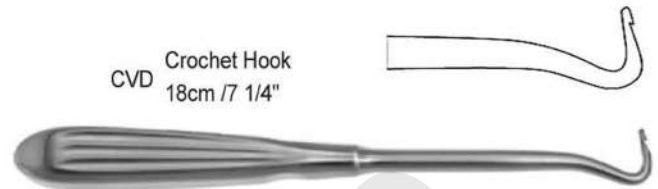

CVD Crochet Hook
18cm / 7 1/4"

RD-03-0430
Bankert Ligature Carrier

CVD
Crochet Hook Fiber handle
A: 18cm / 7" B: 23cm / 9"

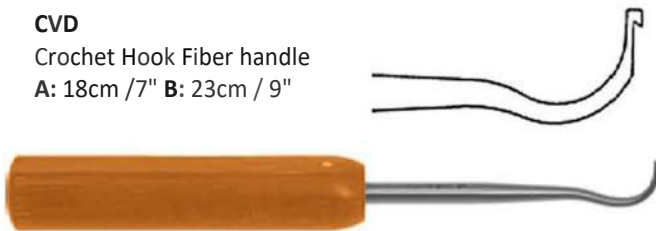

RD-03-0431
Suture Passer

CVD
Suture Hole Fiber Handle
A: 18cm / 7" B: 23cm / 9"



RD-03-0432
Suture Passer



Suture Hole
20cm / 8"
A: Right Blunt
B: Left Blunt
C: Right Sharp
D: Left Sharp

RD-03-0433
Deschamps Ligature Carrier

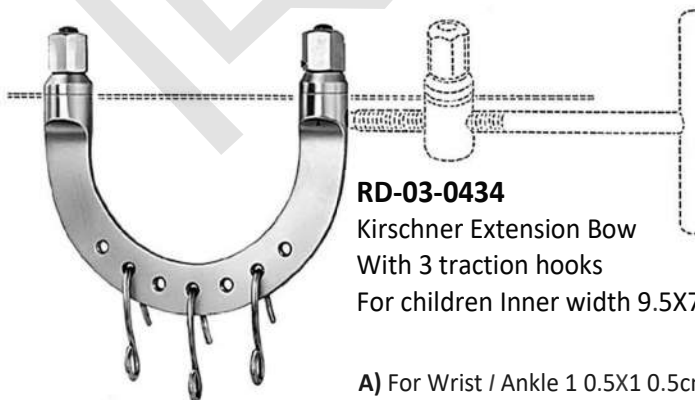

RD-03-0434
Kirschner Extension Bow
With 3 traction hooks
For children Inner width 9.5X7cm

A) For Wrist / Ankle 1.0X1.0.5cm
B) For Elbow 12X12cm
C) For Knee 15.5X15.5cm
D) For Femur 20X15.5cm

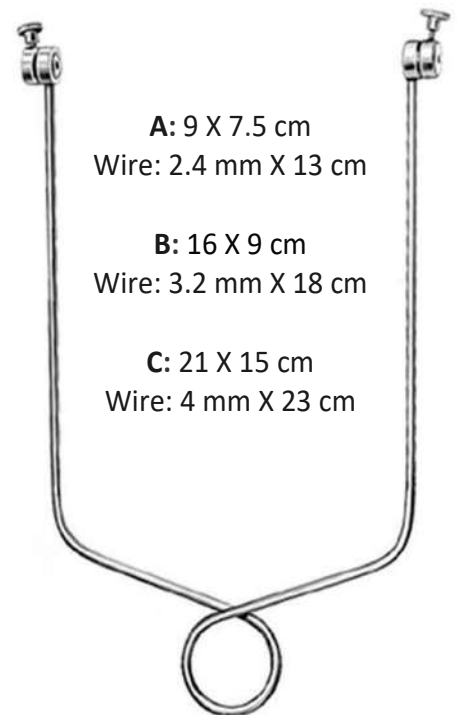

A: 9 X 7.5 cm
Wire: 2.4 mm X 13 cm

B: 16 X 9 cm
Wire: 3.2 mm X 18 cm

C: 21 X 15 cm
Wire: 4 mm X 23 cm

RD-03-0435
Bohler Extension Bow for femur & knee

WIRE INSTRUMENTS – EXTENSION BOWS

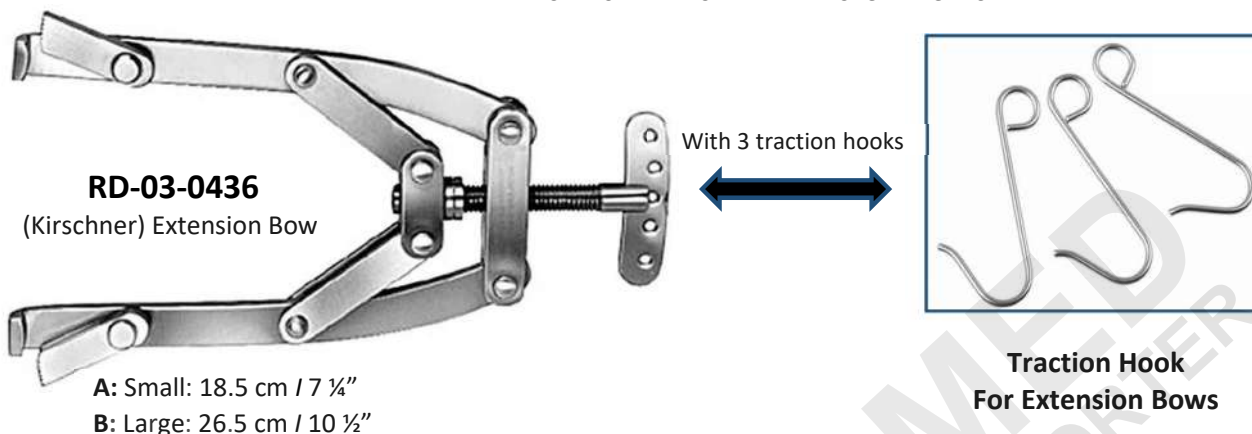

RD-03-0437
Extension Bow
A: 10 ½" X 6 ¼"
B: 7" X 4"



RD-03-0438
Wire Strainer 18.5 cm / 7 ¼"



RD-03-0439
Wrench 20 cm / 8"



RD-03-0440
Fixation Discs
For wire drills, pair

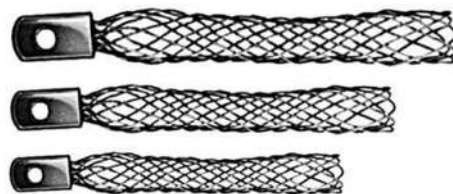

RD-03-0441
Extension Sleeve
Small / Medium / Large

RING CUTTERS – LEAD HANDS – BIOPSY TOOLS



Complete with Drills
(Set of 3 drills) Small / Medium / Large
RD-03-0442
Martin-Ideal
Finger Nail Drill



RD-03-0443
Feldheim Tourniquet 10 cm / 4"

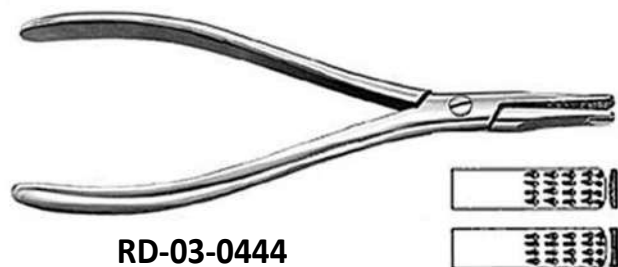

RD-03-0444
Radolf Nail Extracting Forceps
14 cm / 5 1/2"

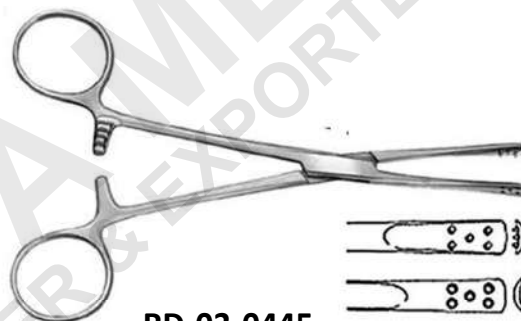

RD-03-0445
Nail Extracting Forceps 16 cm / 6 1/4"



RD-03-0446
Martin Finger Ring Saw 18.5 cm / 6 3/4"
Spare Blades are Available Separately



RD-03-0447
Walton Finger Ring Saw 16cm / 6 1/4"
Spare Blades are Available Separately



RD-03-0448
Finger Ring Saw 17cm / 6 3/4"
Spare Blades are Available Separately



Stainless Steel
Black Color



Stainless Steel
Color

RD-03-0449
Finger Ring Saw Cutter Spare

RING CUTTERS – LEAD HANDS – BIOPSY TOOLS



RD-03-0450

Lead Hand for Kids / Adults

RD-03-0451

Lead Hand for Kids / Adults

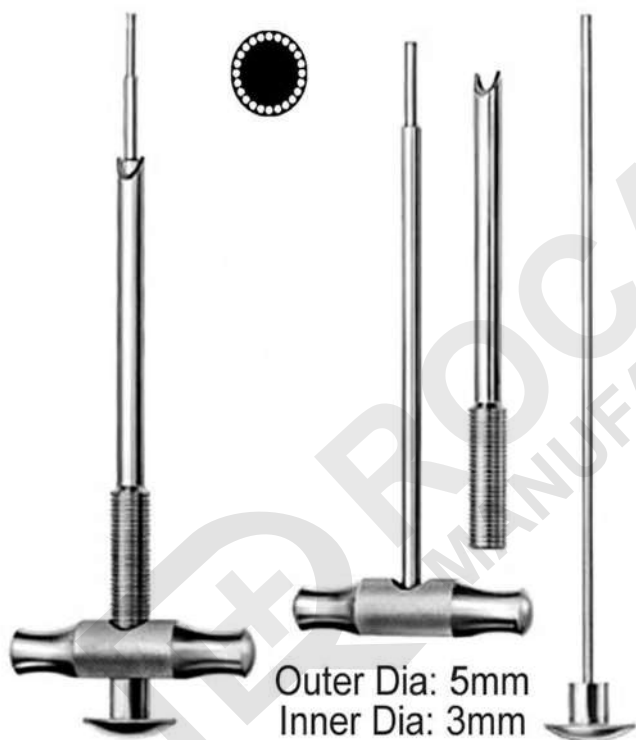

Outer Dia: 5mm
Inner Dia: 3mm

RD-03-0452

Champany-OSU Bone Biopsy Instruments

22 cm / 8 3/4"

Consisting of trocar, a toothed trephine and a plunger for taking tibial and iliac bone grafts through a closed technique



RD-03-0453

Champany Bone Biopsy Instruments

22 cm / 8 3/4"

- A) Outer Dia: 5mm / Inner Dia: 4mm
- B) Outer Dia: 8mm / Inner Dia: 7mm

BONE TAMPERS - IMPACTORS - PACKERS



RD-03-0454

Bone Tamper

15.5 cm / 6" Tip

Sizes: 2-3-4-5-6-8-9-10 mm



A: 2 mm **B:** 3 mm **C:** 4 mm **D:** 5 mm

E: 6 mm **F:** 8 mm **G:** 9 mm **H:** 10 mm



RD-03-0455

Champy Cancellous Bone graft Mill

Outer Dia: 17mm

Inner Dia: 16mm

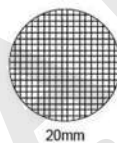

RD-03-0456

Bone Impactor / Teflon Tip 17cm / 6 1/2"



RD-03-0457

Caspar Bone Tamper 20 cm / 8"

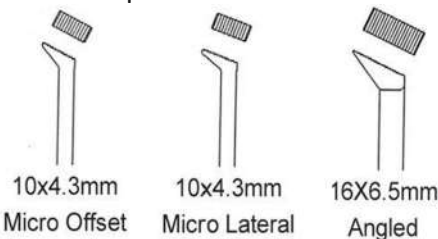

RD-03-0458

Lumbar / Cervical Impactor 21cm / 8 1/2"



RD-03-0459

Lumbar / Cervical Impactor 21cm / 8 1/2"

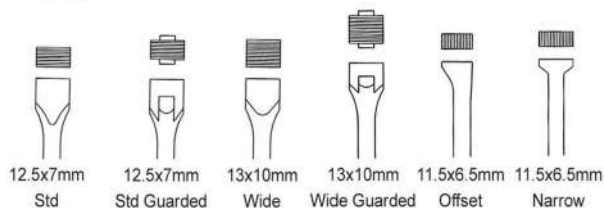

BONE RASPS - FILES



RD-03-0460

Bone Chip Packer 25cm / 10"

A: 2.X9mm B: 3X16mm
C: 6X9mm D: 6X19mm
E: 6mm Dia

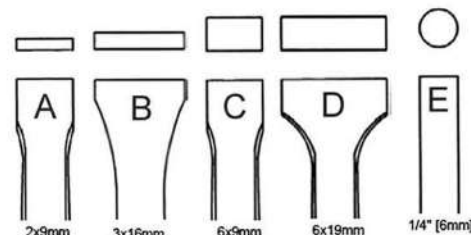

RD-03-0461

Bone Tamper 43 cm / 17"



RD-03-0462

Putti Bone Rasp Round / Semi Round
30 cm / 11 3/4"



RD-03-0463

Putti Bone Rasp Curved / Straight
27cm / 10 3/4"



RD-03-0464

Bone File 28 cm / 11" w/ Hollow Handle Semi Round

5mm

3mm



RD-03-0465

Bone File 24.5 cm / 9 3/4" w/ Hollow Handle Semi

5mm



RD-03-0466

Bone File 22 cm / 8 3/4" Flat / Round



3mm

RD-03-0467

Bone Rasp 22 cm / 8 3/4" Flat / Round



RD-03-0468

Bone File Fiber Handle 18cm / 7"

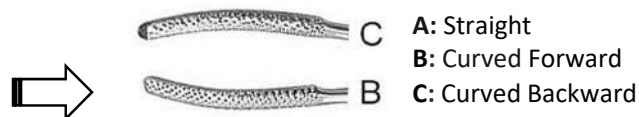

RD-03-0469

Bone File 18 cm / 7" Fiber Handle / Cross-Hatch



RD-03-0470

Bone File 18 cm / 7" Fiber Handle / Linear

BONE RASPS - FILES



RD-03-0471A

Bone File 18 cm / 7" Fiber Handle / STR Diamond Coated



RD-03-0471B

Bone File 18 cm / 7" Fiber Handle / CVD Diamond Coated



RD-03-0472A

Bipolar Bone Rasp w / Rod



Bipolar Bone Rasp w / Rod

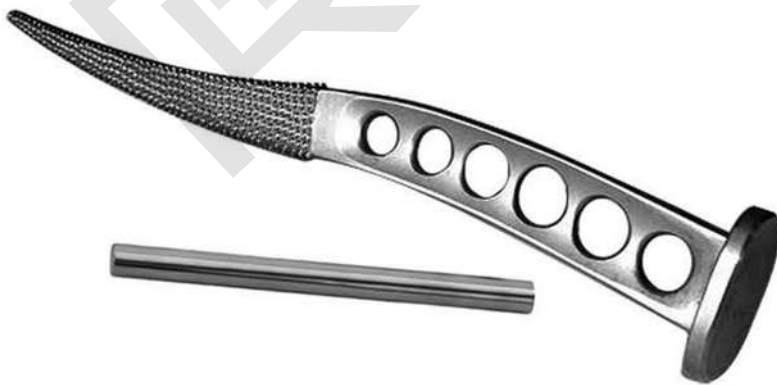

RD-03-0472B

Femoral Bone Rasp w / Rod
A: Small B: Medium C: Large

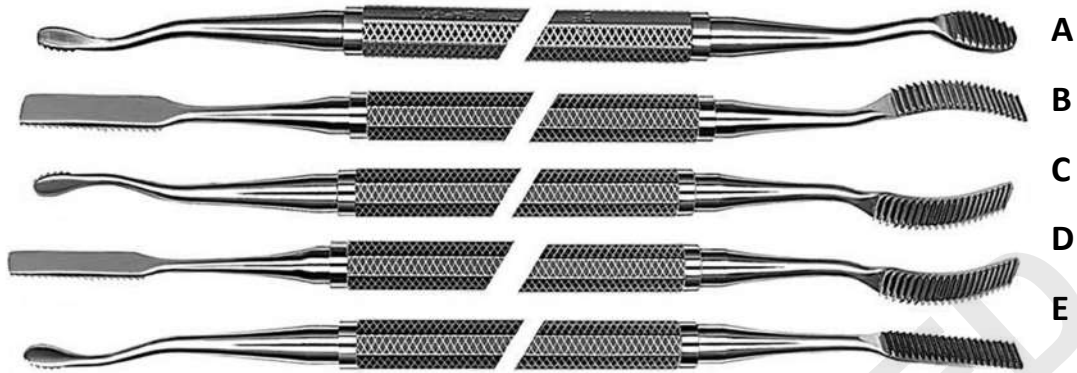

RD-03-0473

Miller-Colburn Bone File 18 cm / 7" Downwards Cut

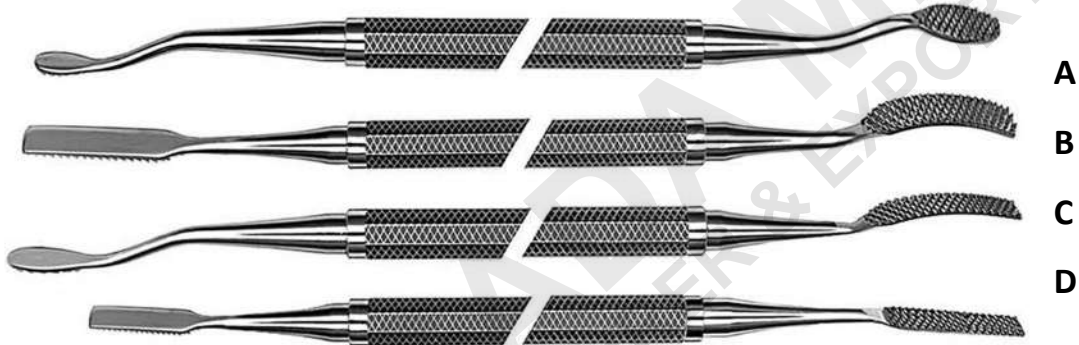

RD-03-0474

Miller-Colburn Bone File 18 cm / 7" Cross Cut

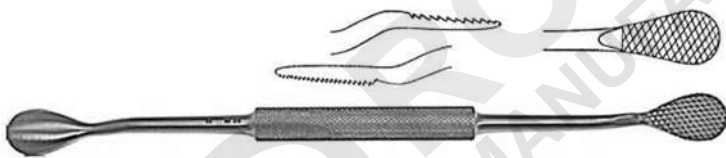

RD-03-0475

Bone Rasp 21 cm / 8.5" 13mm Fine/Coarse
Straight

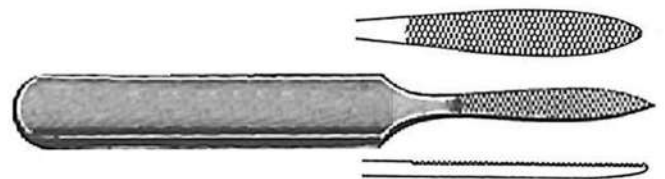

RD-03-0476

Bone Rasp Joseph 16 cm / 6.25" 8mm
Fine Cross Serrated / Straight

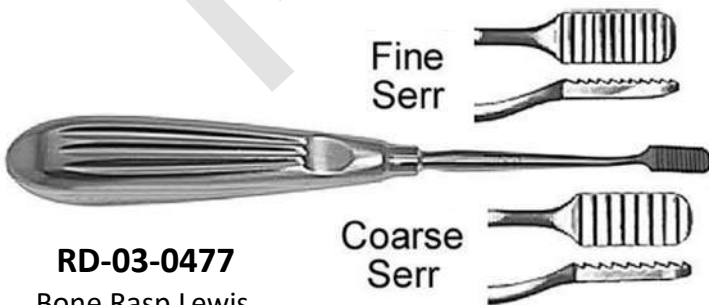

RD-03-0477

Bone Rasp Lewis
19 cm / 7.5" 8mm

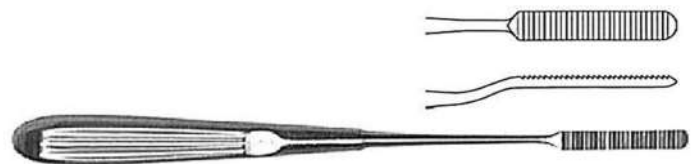

RD-03-0478

Bone Rasp

BONE RASPS - FILES

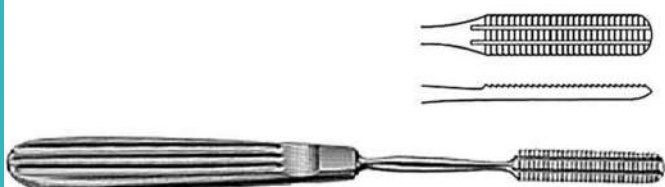

RD-03-0479

Bone Rasp Maltz 18 cm / 7"
9mm Plain Coarse Serr Downward

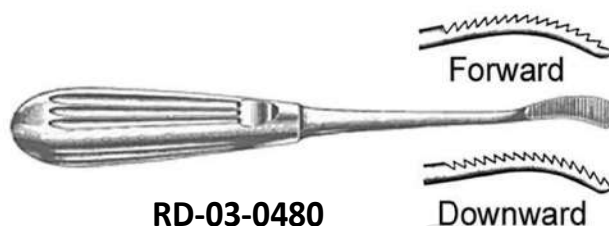

RD-03-0480

Bone Rasp Aufriecht 18 cm / 7"
9mm Coarse Serr CVD

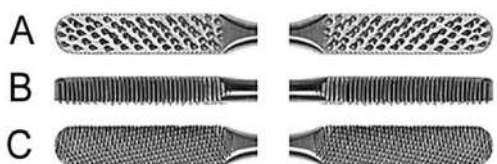

RD-03-0481

Bone Rasp Fomon 21 cm / 8.5"
8mmX40mm Course Serr 4 Sided Flat / Convex Baldes



RD-03-0482

Bone Rasp Fomon 21 cm / 8.5"
8mmX40mm Fine Serr 4 Sided Flat / Convex Blades



RD-03-0483

Bone Rasp Kleinert Kurtz 21 cm / 8.5"
8mmX45mm Fine/Coarse Serr 4 Sided Flat / Convex
Blades

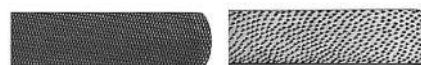

RD-03-0484

Bone File / Rasp 21 cm / 8.5"
18mm Fine / Coarse Serr

BONE LEVERS - RETRACTORS



RD-03-0485

Bone Lever 16 cm / 6 1/4"



RD-03-0486

Hohman, Mini Bone Lever 16 cm / 6 1/4" 6 mm tip



RD-03-0487

Hohman, Mini Bone Lever 16 cm / 6 1/4" 8 mm tip



RD-03-0488

Mini Bone Lever 16cm / 6 1/4" 14 mm tip



RD-03-0489

Hohman, Mini Bone Lever 12 cm / 4 3/4" 14 mm tip

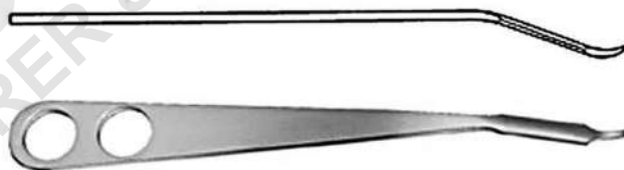

RD-03-0490

Hohmann Bone Lever 22 cm / 8 3/4" 8 mm Tip narrow tip



RD-03-0491

Hohmann Bone Lever 23.5 cm / 9 1/4" 18 mm Tip narrow tip

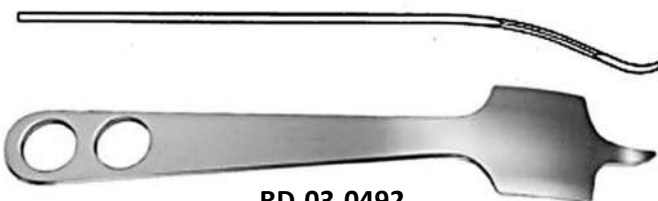

RD-03-0492

Hohmann Bone Lever 23.5 cm / 9 1/4" 43 mm Tip narrow tip



RD-03-0493

Hohmann Bone Lever 29 cm / 11 1/2" 35mm Tip wide tip



RD-03-0494

Lange-Hohmann Bone Lever 25 cm / 9 3/4" 22mm Tip
Wide tip with groove

BONE LEVERS - RETRACTORS

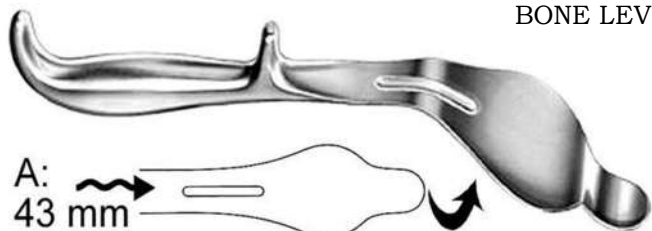

RD-03-0495
Bennett Bone Lever 24 cm / 9 1/2"



RD-03-0496
Hohmann Bone Lever 27.5 cm / 10 3/4"
24mm Tip wide, round tip



RD-03-0497
Hohmann Bone Lever 25 cm / 9 3/4" 70 mm Tip narrow tip



RD-03-0498
Blount Knee Retractor 26.5 cm / 10 1/2" blunt



RD-03-0499
Hohmann Bone Lever 23.5 cm / 9 1/4" 43mm Tip narrow tip



RD-03-0500
Blount Knee Retractor 26.5 cm / 10 1/2"



RD-03-0501
Hohmann Bone Lever 25.5 cm / 10" 22mm Tip wide tip

Sizes Available:

- A: 75 X 30 mm
- B: 100 X 30 mm

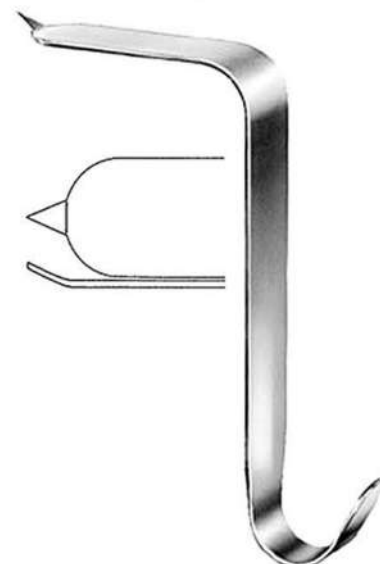

RD-03-0503
Taylor Spinal Retractor
16 cm / 6 1/4"
Pointed end



RD-03-0502
Blount Knee Retractor 17.5 cm / 7"

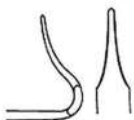

BONE LEVERS - RETRACTORS

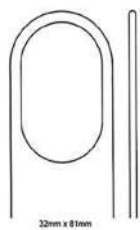

RD-03-0504
Fukuda Retractor
19 cm / 7 1/2"
T-Handle

A: 32X81mm
B: 38X81mm

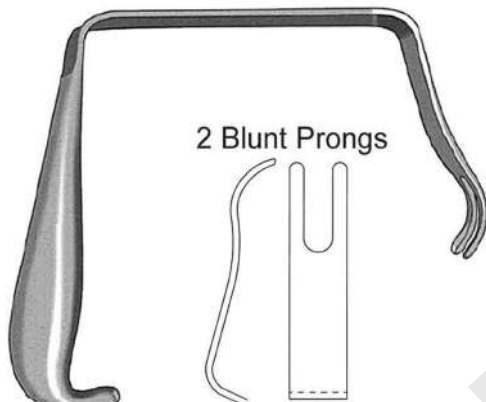

2 Blunt Prongs

RD-03-0505
Bristow / Bankart Humeral Retractor
18 cm / 7"



Medium Blade:
57 /69mm Deep
11mm Wide

Large Blade:
63/76mm Deep
11mm Wide

RD-03-0506
Z Knee Retractor 15 cm / 6"



RD-03-0507
Deltoid Retractor 28 cm / 11" T Handle w / Ring

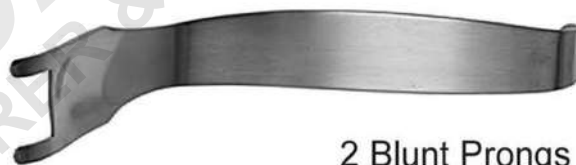

RD-03-0508
Humeral Head Retractor 18 cm / 7" Strong Curved
2 Blunt Prongs

22 mm Blade
1 Sharp Prong

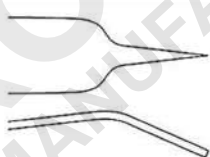

RD-03-0509
Capsule Retractor 25 cm / 10"

22 mm Blade
2 Sharp Prong

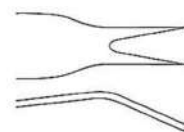

RD-03-0510
Capsule Retractor 25 cm / 10"

3 Sharp Prongs

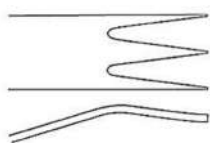

RD-03-0511
Capsule Retractor 25 cm / 10"

Soft Tissue Retractor
3 Blunt Prong

22mm
Blade

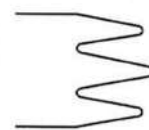

RD-03-0512
Capsule Retractor 25 cm / 10"

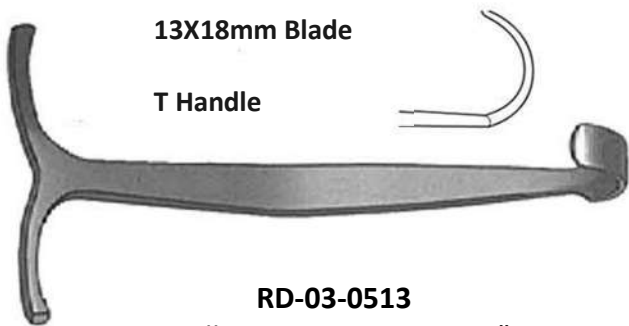

13X18mm Blade

T Handle

RD-03-0513

Smillie Retractor 13 cm / 5"



13X55 mm Blade

T Handle

RD-03-0514

Smillie Retractor 14 cm / 5 1/2"

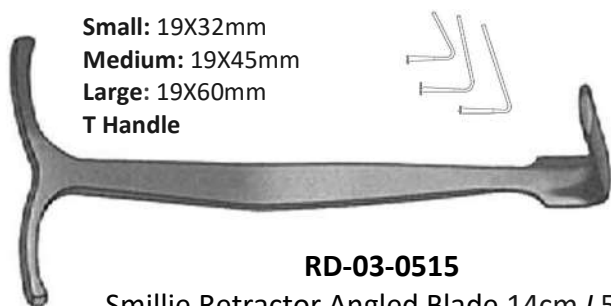

Small: 19X32mm
Medium: 19X45mm
Large: 19X60mm
T Handle

RD-03-0515

Smillie Retractor Angled Blade 14cm / 5 1/2"



9 X 38 mm Blade

RD-03-0516

Knee Retractor 22 cm / 8 1/2" Ring Handle

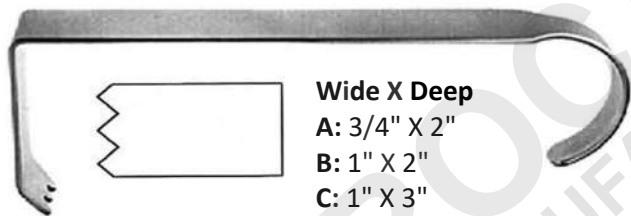

Wide X Deep

A: 3/4" X 2"
B: 1" X 2"
C: 1" X 3"
D: 1" X 4"

RD-03-0517

Hibbs Retractor 24 cm / 9 1/2" Sharp Teeth

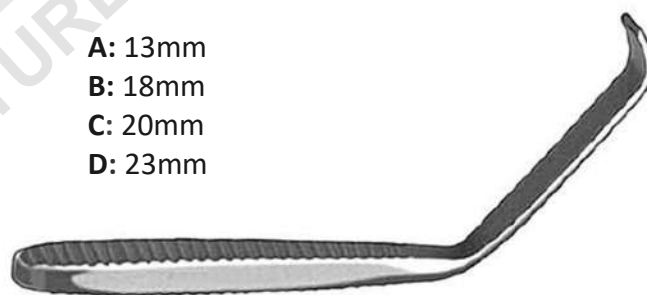

A: 13mm
B: 18mm
C: 20mm
D: 23mm

RD-03-0518

Blade Retractor 19 cm / 7 1/2"

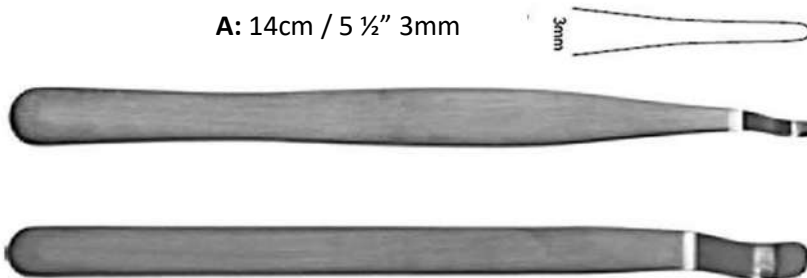

A: 14cm / 5 1/2" 3mm

B: 15cm / 6" 7mm

RD-03-0519 Hayes Retractor

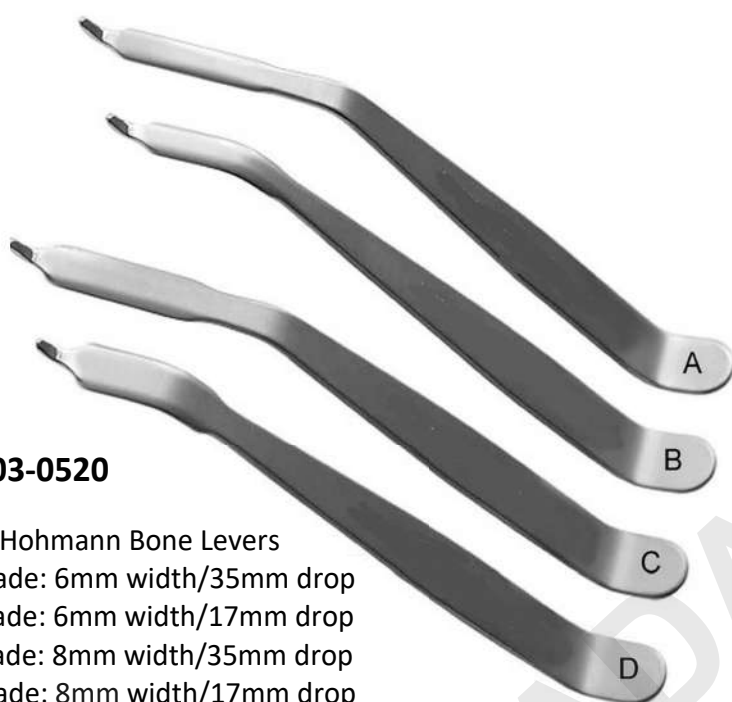

RD-03-0520

Mini Hohmann Bone Levers

A: Blade: 6mm width/35mm drop

B: Blade: 6mm width/17mm drop

C: Blade: 8mm width/35mm drop

D: Blade: 8mm width/17mm drop

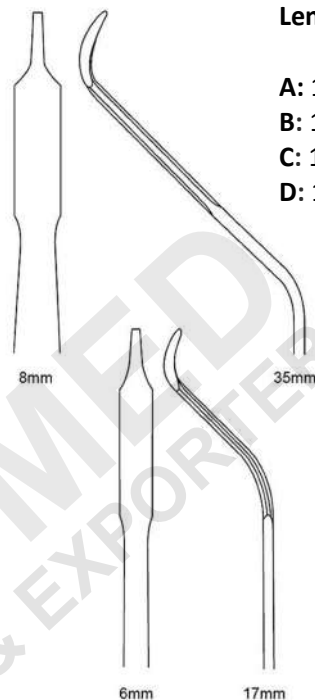

Length:

A: 15cm / 6"

B: 15.5cm/6 ¼"

C: 15cm/6"

D: 15.5cm/6 ¼"

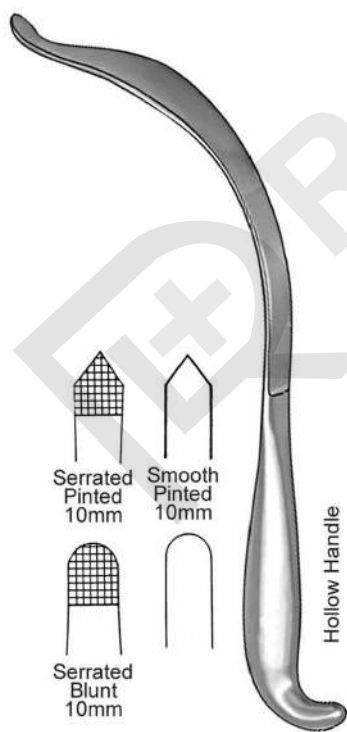

RD-03-0521

Aufranc Cobra Retractor
26 cm / 10 ½"



RD-03-0522

Aufranc Cobra Retractor
27.5cm / 11"

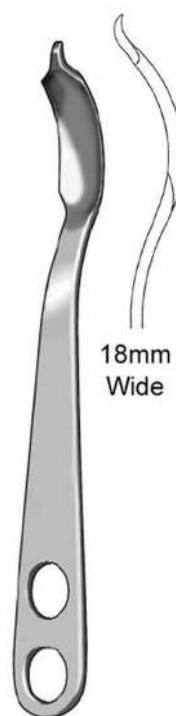

Humeral Head Retractor
RD-03-0523
23 cm / 9"

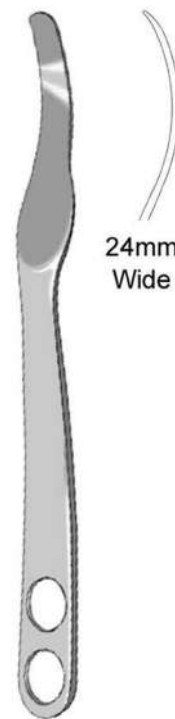

RD-03-0524

Pelvic Retractor Single Prong
26 cm / 10 ½"

BONE LEVERS - RETRACTORS



Ribbon Retractor Malleable
30 cm / 12"

RD-03-0525

AVAILABLE SIZES:

- | | | |
|------------------|---------------|---------------|
| A: 6" X 6mm | G: 8" X 10mm | M: 13" X 38mm |
| B: 6" X 12mm | H: 8" X 12mm | N: 13" X 45mm |
| C: 6" X 16mm | I: 8" X 16mm | O: 13" X 50mm |
| D: 6" X 19mm | J: 8" X 19mm | P: 13" X 65mm |
| E: 7 1/2" X 25mm | K: 13" X 19mm | Q: 13" X 75mm |
| F: 8" X 6mm | L: 13" X 30mm | |



RD-03-0526

Murphy Bone Skid
30 cm / 12"

- A: 22mm Blade
2 Finger Rings Long Round
- B: 22mm Blade
1 Finger Ring Short Round

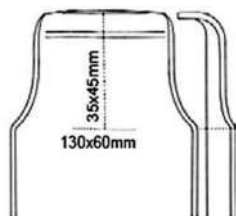
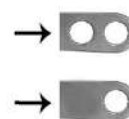

A: 29cm / 11 1/2" With Lip



B: 33cm / 13" With Lip

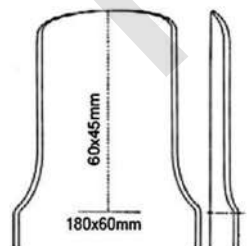

C: 33cm / 13" Without Lip



RD-03-0527

St. Mark's Pelvic Retractor
Angled Blade

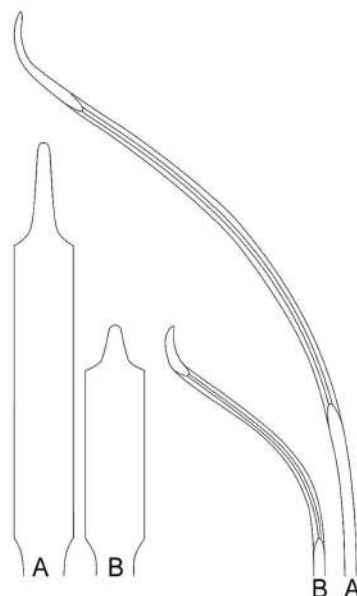

RD-03-0528

Hohmann Retractor
40cm / 16"



BONE LEVERS - RETRACTORS

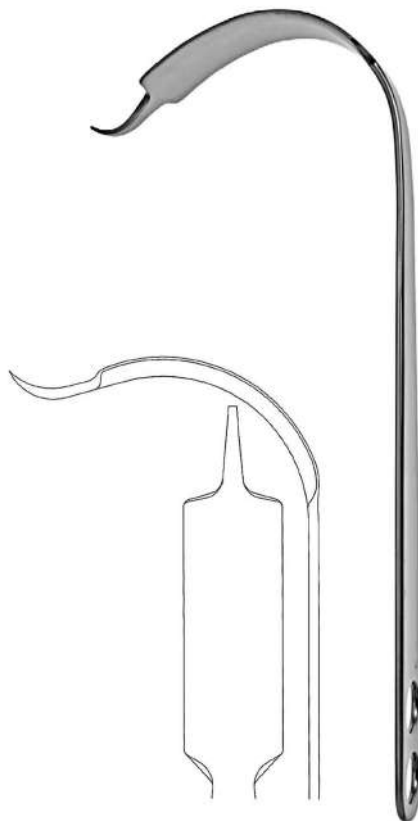

RD-03-0529

Hohmann Retractor
33 cm / 13"
40mm Blade Width



RD-03-0530

Virchow Skull Breaker
7.5 cm / 3" 40 mm Blade Width

RD-03-0531

Buckley Chisel
16cm / 6 1/4"
Octagonal handle

Fig A: 2mm
Fig B: 3mm
Fig C: 4mm



RD-03-0532

Buckley Gouge
16cm / 6 1/4"
Octagonal handle

Fig A: 2mm
Fig B: 3mm
Fig C: 4mm



Fig C: 5mm Fig B: 4mm Fig A: 3mm

RD-03-0533

Stout Bone Chisel 21 cm / 8 1/4" octagonal handle



RD-03-0534

Bone Chisel 18 cm / 7" Round Handle

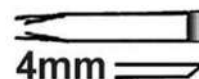

RD-03-0535

Bone Chisel 17 cm / 6 3/4" Round Handle

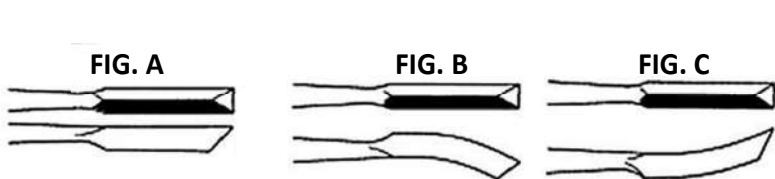
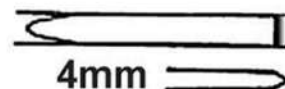

RD-03-0536

Gardner Bone Chisel 17 cm / 6 3/4" 4 mm

CHISELS - OSTEOTOMES - GOUGES

FIG A: 3 mm

FIG B: 5 mm

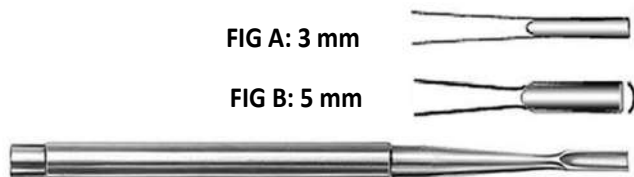

RD-03-0537

Snyder-O.S.U Bone Chisel 16.5 cm / 6 1/2" 3 mm / 5 mm

4mm



RD-03-0538

Bone Chisel 18 cm / 7" Octagonal Handle 4 mm

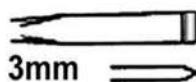

RD-03-0539

Bone Chisel 18 cm / 7" Octagonal Handle 3 mm



FIG A

FIG B



RD-03-0540

O.S.U. Bone Chisel 17 cm / 6 3/4" 7 mm / 9 mm

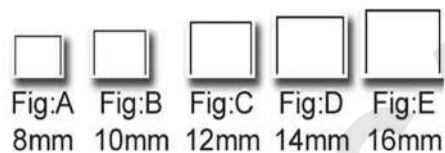

Side View



RD-03-0541

Osteotome 13.5 cm / 5 1/4"

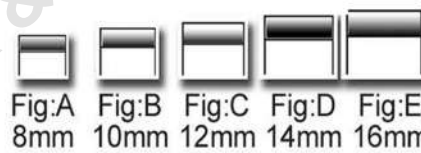

Side View



RD-03-0542

Chisel 13.5 cm / 5 1/4"



Side View



RD-03-0543

Gouge 13.5 cm / 5 1/4"

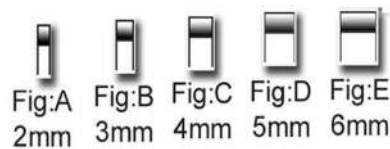

Side View



RD-03-0544 Partsch Chisel 13.5 cm / 5 1/4"

RD-03-0545 Partsch Chisel 17 cm / 6 3/4"

CHISELS - OSTEOTOMES - GOUGES



RD-03-0546 Partsch Gouge 13.5 cm / 5 1/4"

RD-03-0547 Partsch Gouge 13.5 cm / 5 1/4"



RD-03-0548 Alexander Gouge 17.5 cm / 7"

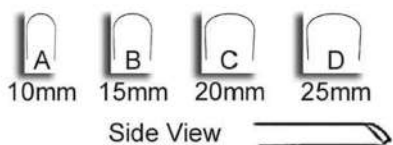

RD-03-0549 Stille Gouge 20 cm / 8"

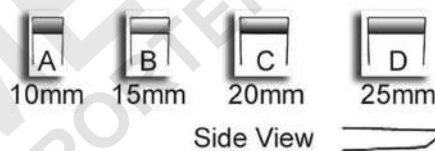

RD-03-0550 Stille Chisel 20 cm / 8"

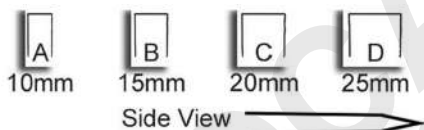

RD-03-0551 Stille Osteotome 20 cm / 8"

RD-03-0555
Lambotte, Osteotome
24 cm / 9 1/2"
Curved Tip



- Available in**
- 15mm
 - 20mm
 - 25mm
 - 30mm
 - 38mm
 - 44mm
 - 50mm

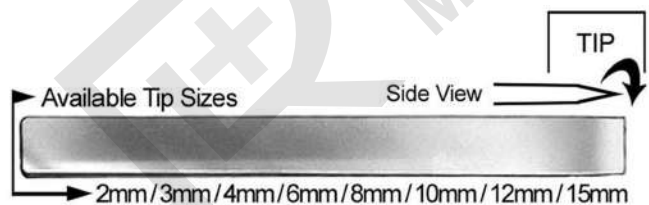

RD-03-0552 (12.5 cm / 5") Lambotte, Mini Osteotome

RD-03-0553 (17 cm / 6 3/4") Lambotte, Mini Osteotome
3mm / 4mm / 6mm / 8mm / 10mm / 12mm / 15mm

RD-03-0554 (24 cm / 9 1/2") Lambotte, Osteotome
15mm / 20mm / 25mm / 30mm / 38mm / 44mm / 50mm

CHISELS - OSTEOTOMES - GOUGES

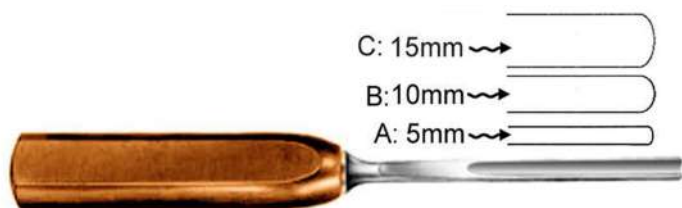

RD-03-0556A
Lexer Spongiosa Gouge (25 cm / 9 3/4")

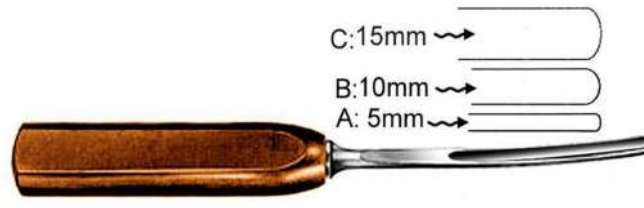

RD-03-0556B
Lexer Spongiosa Gouge (25 cm / 9 3/4")

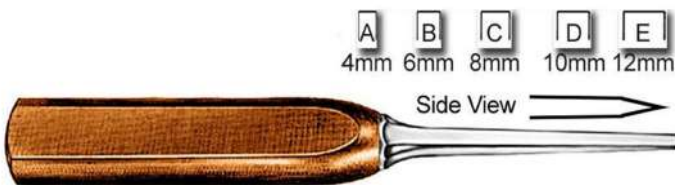

RD-03-0557A
Lexer, Mini Osteotome 18.5 cm / 7 1/4"



RD-03-0557B
Lexer, Mini Osteotome 18.5 cm / 7 1/4"

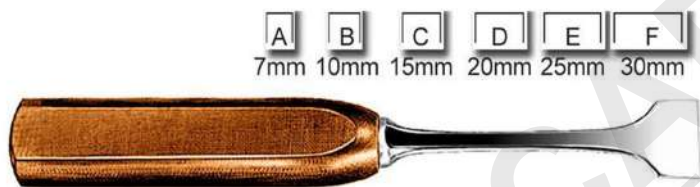

RD-03-0558A
Lexer, Osteotome 22 cm / 8 3/4"

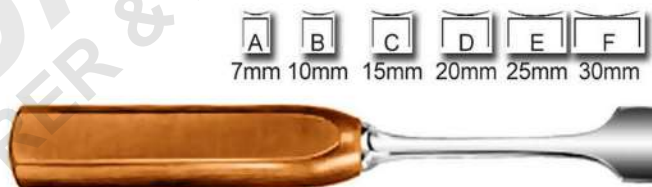

RD-03-0558B
Lexer, Osteotome 22 cm / 8 3/4"



RD-03-0559A
Vickers Spongiosa Gouge 18 cm / 7"

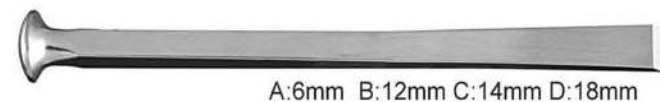

RD-03-0559B
US Army Chisel 18 cm / 7"



RD-03-0560A
US Army Osteotome 18 cm / 7"



RD-03-0560B
US Army Gouge 18 cm / 7"



RD-03-0561A
Smith-Petersen Osteotome 20.5 cm / 8" Straight



RD-03-0561B
Smith-Petersen Osteotome 20.5 cm / 8" Curved

CHISELS - OSTEOTOMES - GOUGES



RD-03-0561C
Smith-Petersen Gouge 20.5 cm / 8" Straight Tip

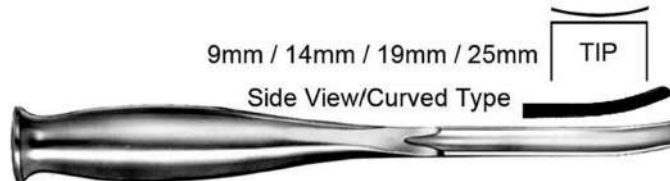

RD-03-0561D
Smith-Petersen Gouge 20.5 cm / 8" Curved Tip



RD-03-0562
Hook Osteotome 17 cm / 6 3/4"



RD-03-0563A
Hibbs Osteotome 24.5 cm / 9 3/4"

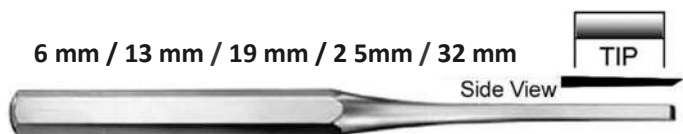

RD-03-0563B
Hibbs Chisel 24.5 cm / 9 3/4"



RD-03-0563C
Hibbs Gouge 24.5 cm / 9 3/4"

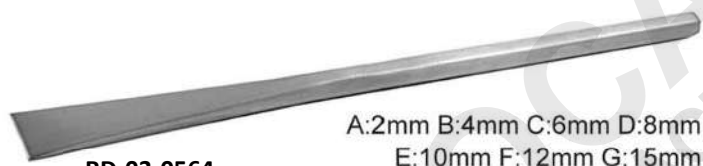

RD-03-0564
Sheehan Osteotome 16cm / 6 1/2"



RD-03-0565A
Silver Osteotome 18 cm / 7" Straight



RD-03-0565B
Silver Osteotome 18 cm / 7" Curved Right



RD-03-0565C
Silver Osteotome 18 cm / 7" Curved Left



RD-03-0566
Shoulder Penetrating Gouge 21 cm / 8 1/2"



RD-03-0567
Swan Neck Gouge 23 cm / 9"

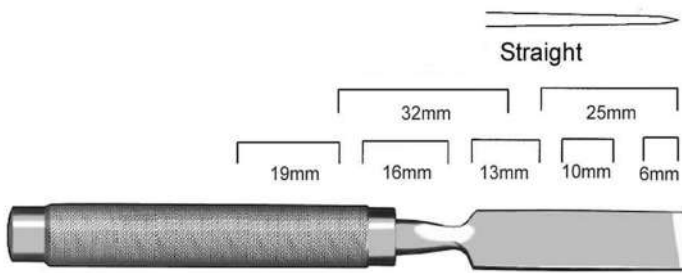

11-01-0568A RD-03-0568A
Cobb Osteotome 28 cm / 11" Straight

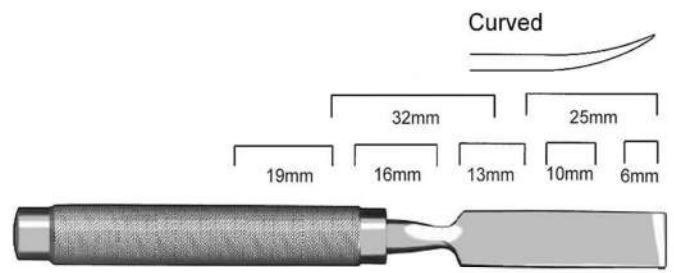

RD-03-0568B
Cobb Osteotome 28 cm / 11" Curved

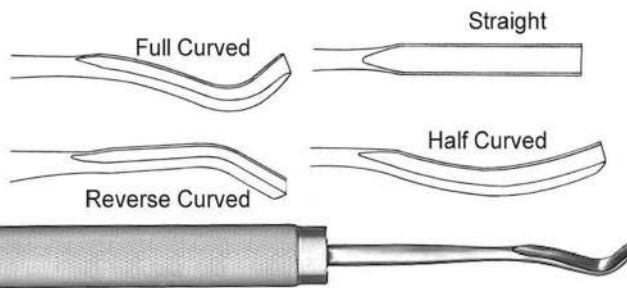

RD-03-0569
Cobb Gouge 28 cm / 11"

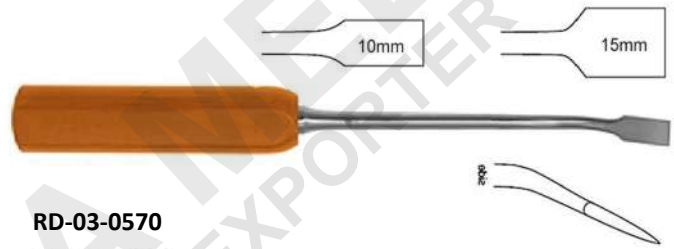

RD-03-0570
Lexer Osteotome Angled / 28 cm / 11"

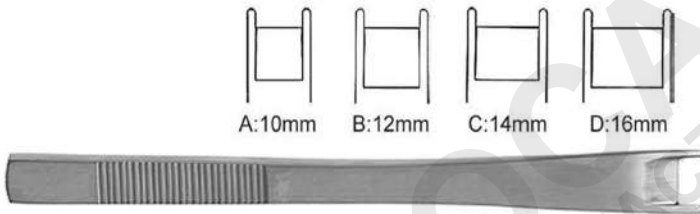

RD-03-0571
Cinelli Osteotome 15.5 cm / 6 1/2"

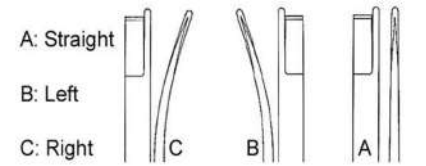

RD-03-0572
Anderson Neivert Osteotome 20 cm / 8"

RD-03-0573
Hibbs Osteotome 47 cm / 18 1/2" 10 mm Tip
3 1/2" Tip L / 10 3/4" Shaft L / 4 1/4" Handle L
11 .5 mm Shaft Diameter



RD-03-0574
Hibbs Gouge 47 cm / 18 1/2" 10 mm Tip
3 1/2" Tip L / 10 3/4" Shaft L / 4 1/4" Handle L
11 .5 mm Shaft Diameter

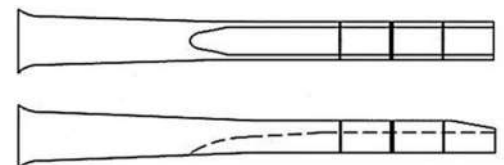
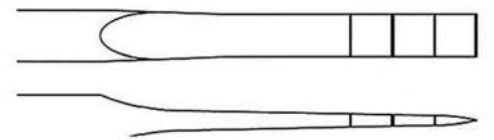

CHISELS - OSTEOTOMES - GOUGES



RD-03-0575

Spinal Fusion Gouge 24 cm / 9 1/2" 6 mm Tip

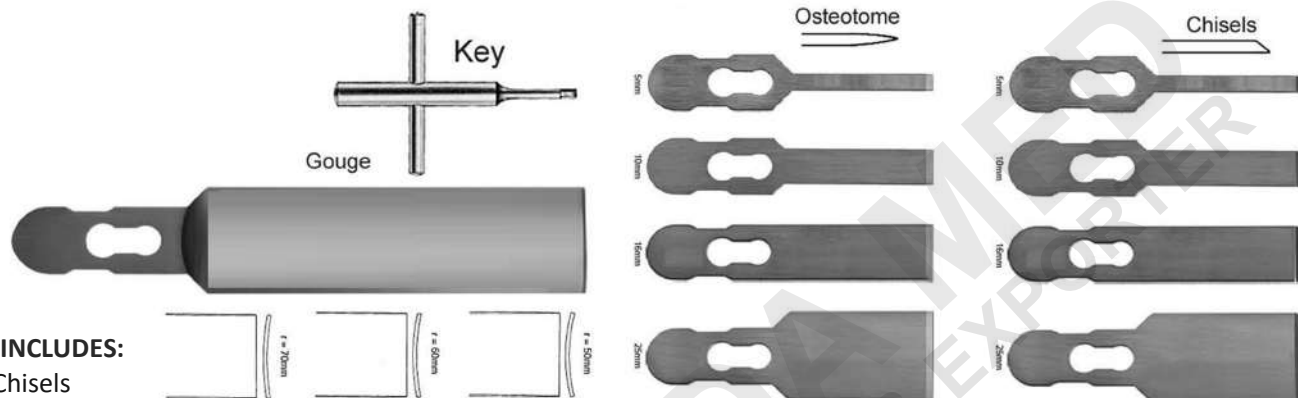

SET INCLUDES:

- 5 x Chisels
- 5/10/15/25mm
- 5 x Osteotomes
- 5/10/15/25mm
- 3 x Gouges
- 50/60/70mm Radius
- 1 x Handle Fibre
- 1 x Key



RD-03-0576

Chisel Handle Fibre w/Chisel-Osteotome-Gouge Blades 18.5 cm / 7 1/4"

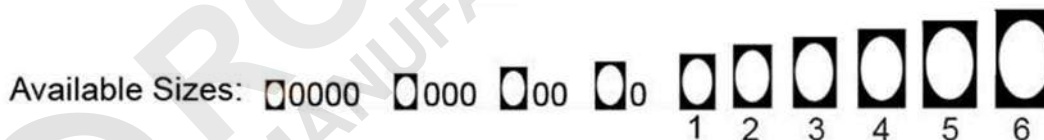

RD-03-0577

Volkman Bone Curette 18.5 cm / 7 1/4" oval with plastic handle



RD-03-0578

Volkman Bone Curette 27.5 cm / 10 3/4" oval with plastic handle

BONE CURETTES

A: 13 cm / 5"
B: 16 cm / 6 ¼"
C: 20 cm / 8"

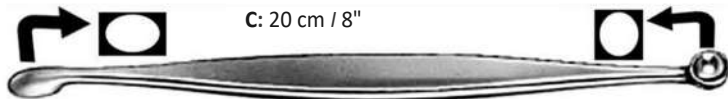

RD-03-0579

Volkman Bone Curette, double-ended (oval / round)



RD-03-0580

Bone Curette, double-ended (round / oval) 21 cm / 8 ¼"



RD-03-0581

Schede Bone Curette 17 cm / 6 ¾" oval with hollow handle

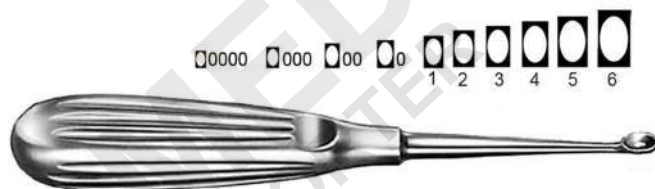

RD-03-0582

Volkman Bone Curette 17 cm / 6 ¾" oval, with hollow handle

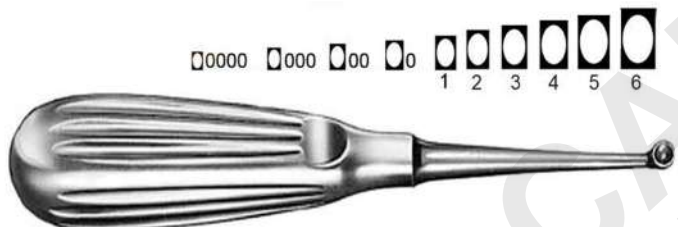

RD-03-0583

Bruns Bone Curette 17 cm / 6 ¾" Round, with hollow handle

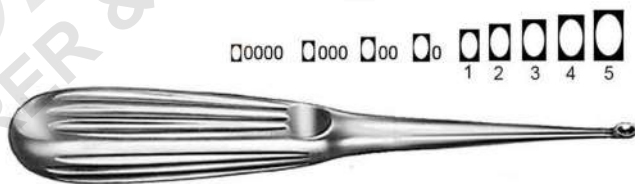

RD-03-0584

Spratt Bone Curette 17 cm / 6 ¾" Oval, with hollow handle

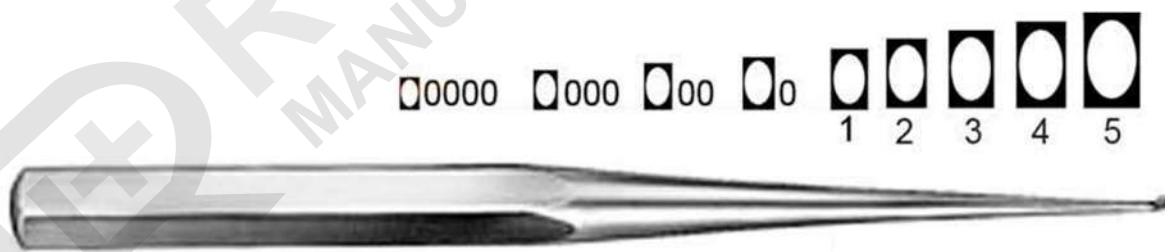

RD-03-0585

Bruns Bone Curette 23 cm / 9" oval, solid



RD-03-0586

Scoville Bone Curette 25 cm / 9 ¾" oval, with hollow handle



BONE CURETTES



RD-03-0587

Simon Bone Curette 25 cm / 9 3/4" oval, with hollow handle



RD-03-0588

Modell USA Bone Curette 16 cm / 6 1/4" Oval, with hollow handle



RD-03-0589

Modell USA Bone Curette 15.5 cm / 6" Oval, with hollow handle



RD-03-0590

BONE CURETTES



RD-03-0591

Halle Bone Curette 21 cm / 8 1/4" oval, malleable shaft, with hollow handle

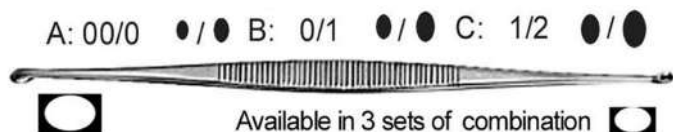

RD-03-0592

Williger Bone Curette, double-ended 13.5 cm / 5 1/4" handle



RD-03-0593

Williger Bone Curette, 17 cm / 6 3/4" double-ended oval / oval



RD-03-0594

A: 12.5 cm / 5"
B: 14.5 cm / 5 3/4"
C: 17 cm / 6 3/4"
Volkman Bone Curette, double-ended

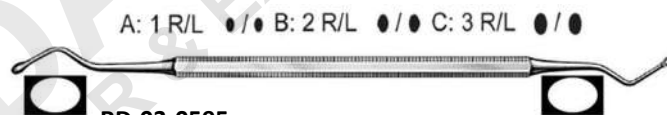

RD-03-0595

Hemingway-Martin Bone Curette, double-ended
18.5 cm / 7 1/4"



RD-03-0596

Bone Curette, 17.5 cm / 7" double-ended round



RD-03-0597

Hemingway Bone Curette, double-ended, round / round
18.5 cm / 7 1/4" octagonal handle

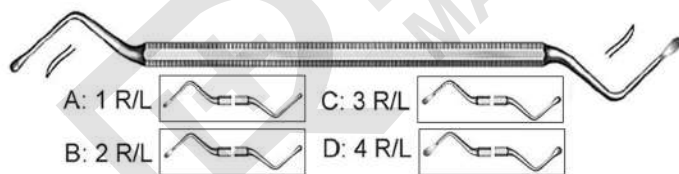

RD-03-0598

Lucas Bone Curette, double-ended 18 cm / 7"
Octagonal handle

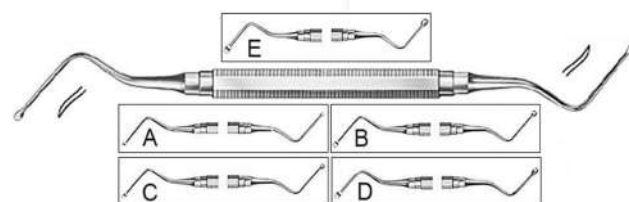

RD-03-0599

Miller-Colburn Bone Curette, double-ended 17 cm / 6 3/4"

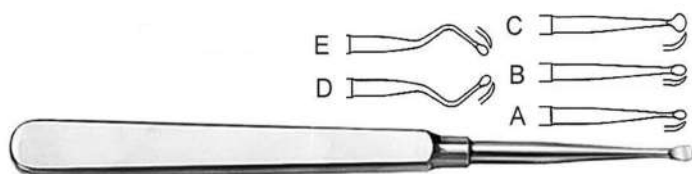

RD-03-05600

Molt Bone Curette 17 cm / 6 3/4"

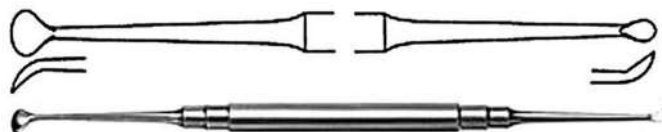

RD-03-0601

Molt Bone Curette 19 cm / 7 1/2" Round Handle

BONE CURETTES

Hollow Handle
Oval Fenestrated
4x7mm Cup
Sharp/Blunt

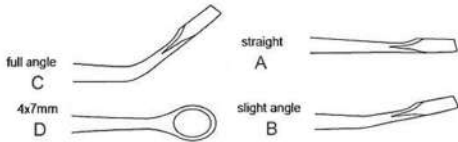

RD-03-0602

Semmes Ring Curette 23 cm / 9"

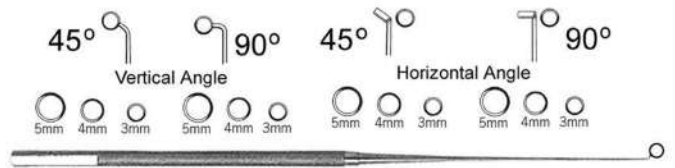

RD-03-0603

Ray Pituitary Curette 18 cm / 7 1/2"

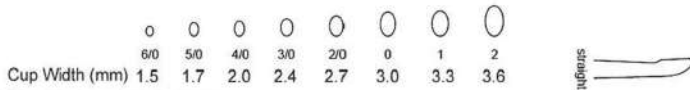

RD-03-0604

Lempert Curette 18 cm / 7 1/2"



RD-03-0605

Epstein Curette 18 cm / 7 1/2"

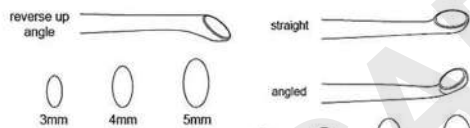

Hollow Handle



RD-03-0606

Bushe Curette 25 cm / 10"

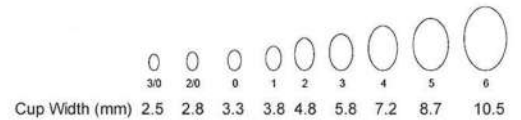

RD-03-0607

Spinal Fusion Curette 28 cm / 11"



RD-03-0608

Scoville Curette 25 cm / 10"



RD-03-0609

Ring Curette

- A: 25 cm / 10" #0 6mm Cup D: 28 cm / 11 1/2" #0 6mm Cup
- B: 25 cm / 10" #2 8mm Cup E: 28 cm / 11 1/2" #2 8mm Cup
- C: 26 cm / 10 1/2" #6 14mm Cup F: 30 cm / 12 1/2" #6 14mm Cup

BONE CURETTES

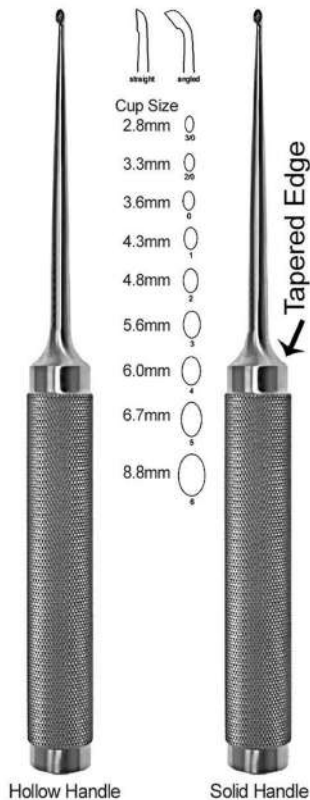

RD-03-0610

Cobb Curette Oval Cups
28 cm / 11"

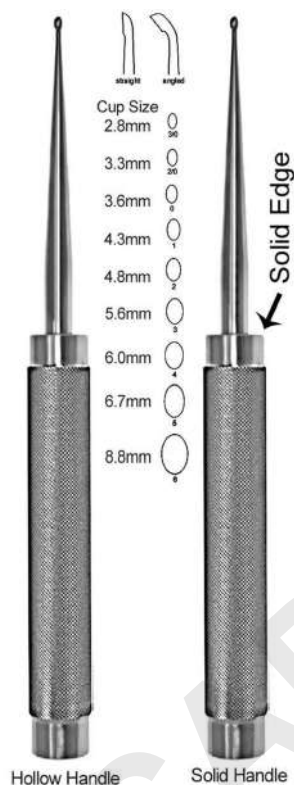

RD-03-0611

Cobb Curette Oval Cups
28 cm / 11"



RD-03-0612

Sypert Curette Long
Delicate Shaft



RD-03-0613

Cone Ring Curette
23 cm / 9"

- A: Straight 8mm Sharp/Blunt
- B: Straight 11 mm Sharp/Blunt
- C: Angled 8mm Sharp/Sharp
- D: Angled 11 mm Sharp/Sharp
- E: Angled 8mm Sharp/Sharp Right Cvd

- F: Angled 11 mm Sharp/Sharp Right Cvd
- G: Angled 8mm Sharp/Sharp Left Cvd
- H: Angled 11 mm Sharp/Sharp Left Cvd



RD-03-0614

Zielke Ring Curette 34 cm / 13 1/2" TEFLON Handle

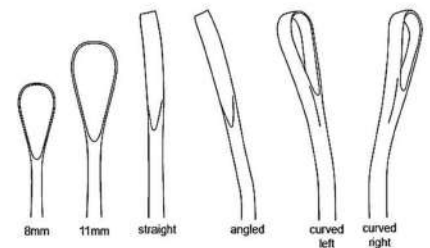

17" Angled 40° 3mm Diameter 2.7"
Tip Length Cone Ring Curette
Endoscopic Fibre Handle 9.3" Shaft
Length 5" Handle Length .285 (7
.2mm) Shaft Diameter

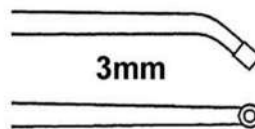

20" Angled 30°
6mm Diameter
3 1/2" Tip Length
10" Shaft Length
6 1/2" Handle Length
45" (11 .5mm)
Shaft Diameter

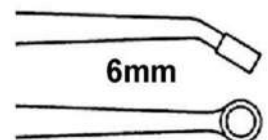

RD-03-0615

Cone Ring Curette Endoscopic Fibre Handle

BONE CURETTES

17" Reverse Angled 40° 3mm x 6mm cup
2.7" Tip Length 9.3" Shaft Length 5" Handle
Length .285 (7.2mm) Shaft Diameter

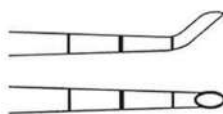

20" Reverse Angled 30°
6mm x 9mm cup 3 1/2"
Tip Length 10" Shaft
Length 6 1/2" Handle
Length .45 (7.2mm)
Shaft Diameter

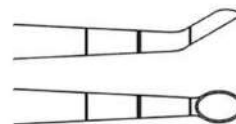

RD-03-0616

Epstein Curette Endoscopic Fibre Handle

A: 17cm / 6 3/4" 8mm | B: 19cm / 7 1/2" 16 mm | E: 18.5cm / 7" 12 mm
C: 19cm / 7 1/2" 16 mm | D: 18.5cm / 7 1/4" 12 mm

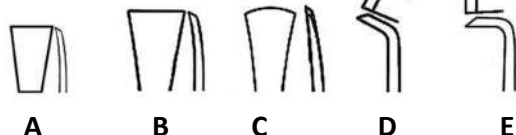

RD-03-0617

Martin-Langenbeck Periosteal Elevator (Solid)

19.5cm / 7 3/4" 6mm tip C: 7mm 4mm tip A: 17.5cm / 7"
19.5cm / 7 3/4" 7mm tip C: 6mm 5mm tip B: 17.5cm / 7"



RD-03-0619

Martin-Langenbeck Periosteal Elevator (Solid)



RD-03-0621

Langenbeck Periosteal Elevator 19.5 cm / 7 3/4"
With hollow handle

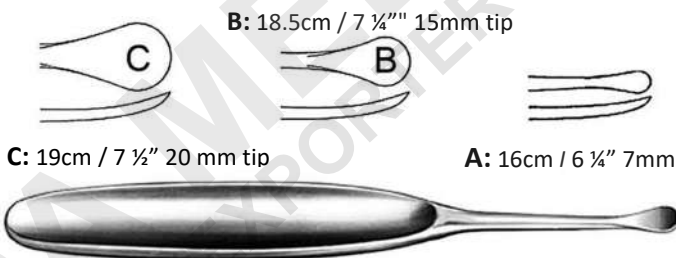

C: 19cm / 7 1/2" 20 mm tip

B: 18.5cm / 7 1/4" 15mm tip

A: 16cm / 6 1/4" 7mm



RD-03-0618

Martin-Langenbeck Periosteal Elevator (Solid)



RD-03-0620

Langenbeck Periosteal Elevator 18.5 cm / 7 1/4"
With hollow handle



RD-03-0622

Periosteal Elevator 16 cm / 6 1/4" Delicate, solid

PERIOSTEAL ELEVATORS



RD-03-0623
Farabeuf Periosteal Elevator 15 cm / 6"
With hollow handle



RD-03-0624
Periosteal Elevator 3mm Tip 18 cm / 7"
Extra narrow, with plastic handle

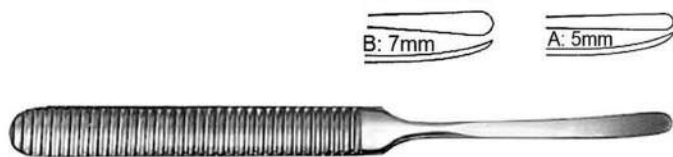

RD-03-0625
Kahre-Williger 16 cm / 6 1/4"
Periosteal Elevator solid



RD-03-0626
Kahre-Williger Periosteal Elevator solid
16cm / 6 1/4"



RD-03-0627
Farabeuf Periosteal Elevator
15 cm / 6" with hollow handle



RD-03-0628
Sedillot Periosteal Elevator 22 cm / 8 3/4" (15mm tip)



RD-03-0629
Periosteal Elevator 20 cm / 8" (14 mm Tip)
With plastic handle



RD-03-0630
Periosteal Elevator 19 cm / 7 1/2"
(14 mm Tip) with plastic handle



RD-03-0631
Periosteal Elevator 6mm Tip
18 cm / 7" narrow, plastic handle



RD-03-0632
Periosteal Elevator 18 cm / 7" narrow,
Plastic handle (6mm Tip)

PERIOSTEAL ELEVATORS - DISSECTORS



RD-03-0633
Williger Periosteal Elevator
12.5 cm / 5" solid 5mm Tip



RD-03-0634
Periosteal Elevator,
Double ended 17.5 cm / 7"

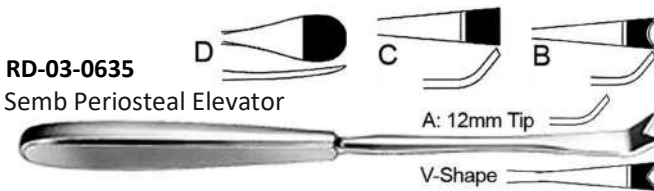

RD-03-0635
Semb Periosteal Elevator
A: 12mm Tip
V-Shape
A+D: 21cm / 8 1/4" & B+C: 18.5 cm / 7 1/4"
A: V-shape 12mm | B: Inside round 12mm
C: Straight 13mm | D: Outer round 15mm



RD-03-0636
Lambotte Periosteal Elevator 21.5 cm / 8 1/2"



RD-03-0637
Periosteal Elevator 20 cm / 8" with plastic handle



RD-03-0638
Periosteal Elevator 17 cm / 6 3/4" with hollow handle

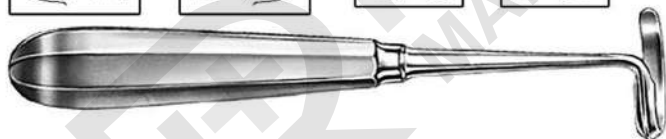
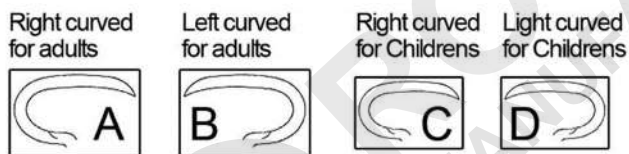

RD-03-0641
Doyen Rib Raspatory 17.5 cm / 7" Rib Raspatories with hollow handle



RD-03-0639
West Periosteal Elevator,
Double-ended 18.5 cm / 7 1/4" octagonal handle



RD-03-0641
Williger Elevator
17 cm / 6 3/4" 7mm tip



RD-03-0643
Elevator 17 cm / 6 3/4" Light weight

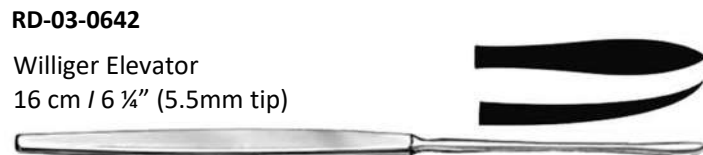

RD-03-0642
Williger Elevator
16 cm / 6 1/4" (5.5mm tip)

PERIOSTEAL ELEVATORS - DISSECTORS



2mm X 3mm Sharp End

RD-03-0644

Kleinert Kutz Elevator 14 cm / 5 1/2"



RD-03-0645

Vickers Dissector 17 cm / 6 3/4"

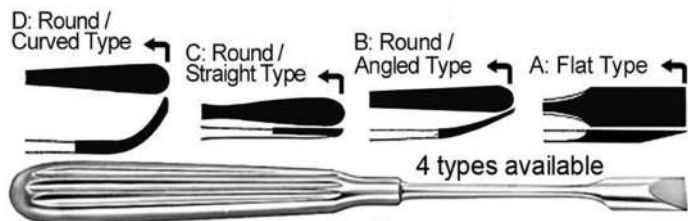

RD-03-0636

Adson Elevator 17.5 cm / 7" A/B/C/D

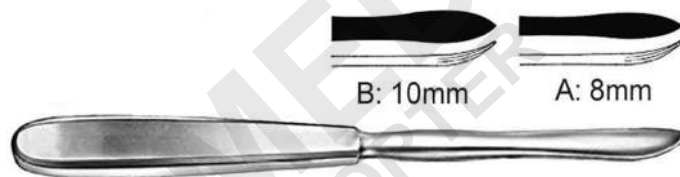

RD-03-0647

Langenbeck Elevator 19.5 cm / 7 3/4" A/B

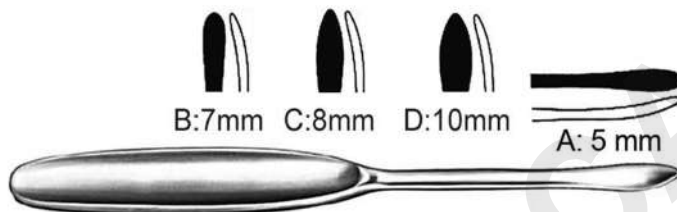

RD-03-0648

Martin Langenbeck Elevator 17 cm / 6 3/4" A/B/C | D: 19.5 cm / 7 3/4"



RD-03-0649

Phalangeal Elevator 16cm / 6 1/4"



RD-03-0650

Alderdyce Dissector, double-ended 21 cm / 8 1/4"

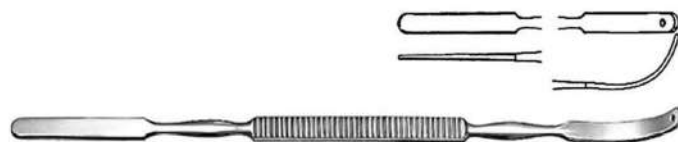

RD-03-0651

McDonald Dissector, double-ended 18.5 cm / 7 1/4"



RD-03-0642

Freer Elevator 19 cm / 7 1/2"



RD-03-0653

Penfield Elevator Endoscopic 38 cm / 15" 5mm Semi Sharp / 1X10mm Blunt Hook



RD-03-0654

Smithwick Hook and Dissector 30 cm / 12" 5mm Semi Sharp / 1X10mm Blunt Hook

PERIOSTEAL ELEVATORS - RESPATORIES

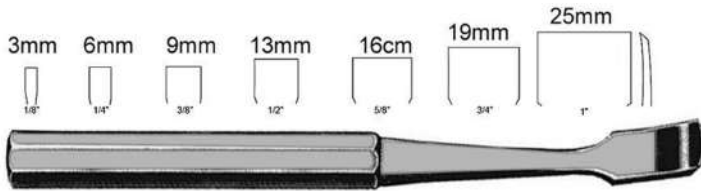

RD-03-0655

Key Elevator 19 cm / 7 1/2" Sharp Edge

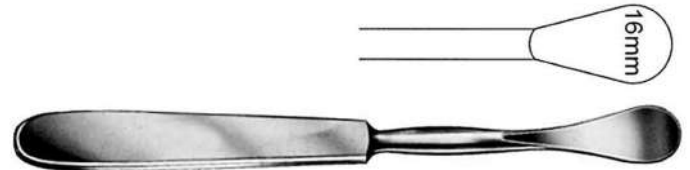

RD-03-0656

Sedilot Elevator 18 cm / 7" Sharp Edge



RD-03-0657

Alexander Periosteal Respiratory 20 cm / 8" / 12mm Sharp

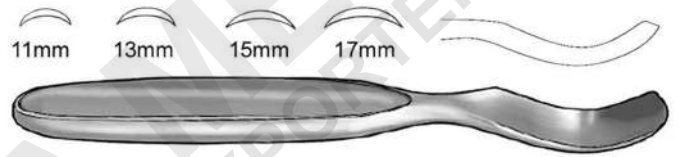

RD-03-0658

MeGiamry Metatarsal Elevator 16 cm / 6 1/2" Sharp

- A: 19cm / 7 1/2" 13mm
- B: 20cm / 8" 19mm
- C: 23cm / 9" 25mm
- D: 25.5cm / 10" 30mm

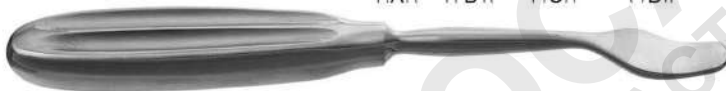
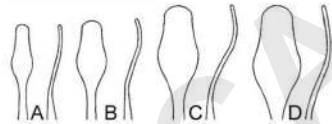

RD-03-0659

Chandler Elevator Blunt



RD-03-0660

Sayre Elevator 16 cm / 6 1/2"

A: Sharp / Blunt B: Blunt/ Blunt



RD-03-0661

Kirmission Periosteal Respiratory 17 cm / 6 3/4"

- A: 14mm Full Curves
- B: 14mm Slight Curves
- C: 7mm Full Curves
- D: 7mm Slight Curves

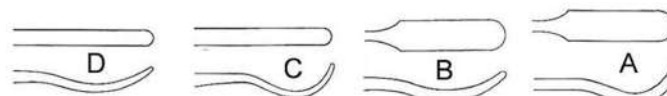

RD-03-0663

Crego Periosteal Elevator 19 cm / 7 3/4" Sharp

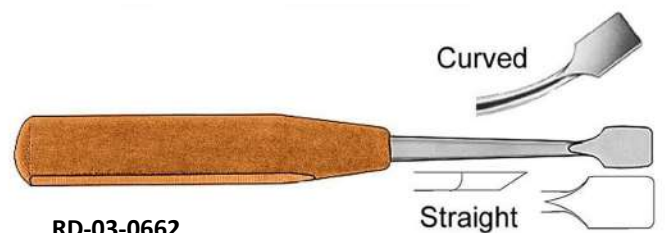

RD-03-0662

Periosteal Elevator 17cm / 6 3/4" Fibre Handle
13mm Blade Sharp

PERIOSTEAL ELEVATORS - DISSECTORS

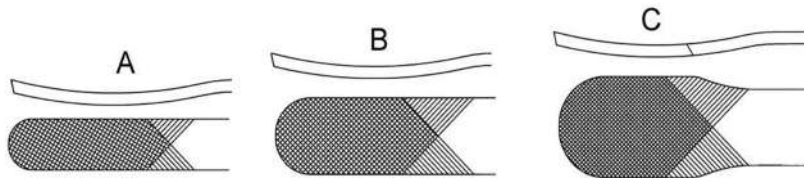

Small

A: 26 cm / 10 ¼" 13mm Width at Tip

Medium

B: 26 cm / 10 ¼" 20mm Width at Tip

Large

C: 35 cm / 13 ¾" 25mm Width at Tip



RD-03-0664

Darraeh Elevator Blunt

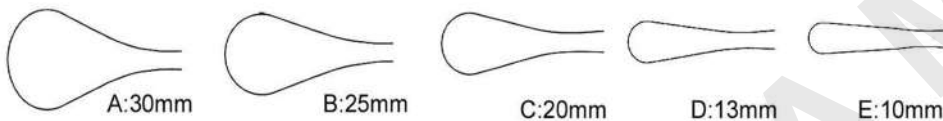

A:30mm

B:25mm

C:20mm

D:13mm

E:10mm



RD-03-0665

Cobb Spinal Elevator Sharp 24cm / 9 ½" Hexa Handle



A:30mm

B:25mm

C:20mm

D:13mm

E:10mm

ALSO AVAILABLE WITH FIBRE HANDLE



RD-03-0666

Spinal Elevator Sharp 28 cm / 11" Knurled Handle

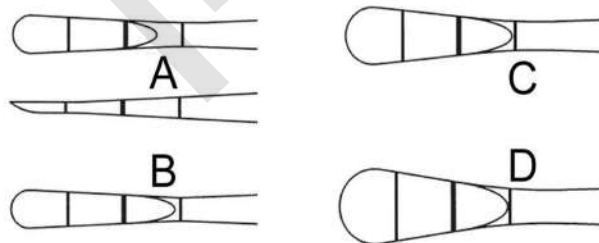

A

C

B

D

A: 43cm / 17"
6mm Tip Width
2.7" Tip Length
9.3" Shaft Length
5" Handle Length
7.2mm Shaft Dia

B: 50cm / 20"
6mm Tip Width
3 1/2" Tip Length
10" Shaft Length
6 1/2" Handle L
11.5mm Shaft Dia

C: 50cm / 20"
10mm Tip Width
3 1/2" Tip Length
10" Shaft Length
6 1/2" Handle L
11.5mm Shaft Dia

D: 50cm / 20"
13mm Tip Width
3 1/2" Tip Length
10" Shaft Length
6 1/2" Handle L
11.5mm Shaft Dia



RD-03-0667

Cobb Elevator Endoscopic Sharp / Fibre Handle

ELEVATORS SPINAL - S/S & FIBRE

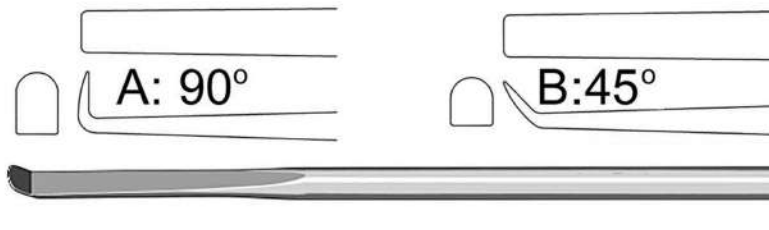

43 cm / 17" - 9mm Tip Radius - 4" Tip
Length 8" Shaft Length - 5" Handle
Length 11 .5mm Shaft Diameter

RD-03-0668

Rib Elevator Endoscopic Sharp / Fibre Handle

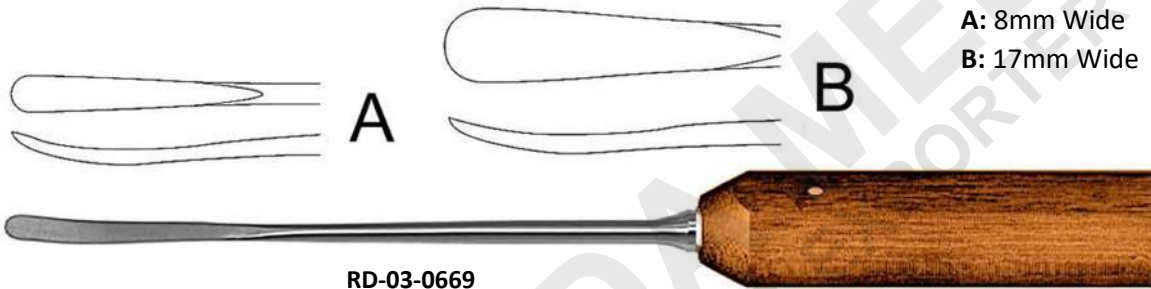

A: 8mm Wide
B: 17mm Wide

RD-03-0669

Wagner Elevator Sharp / Fibre Handle 33 cm / 13"

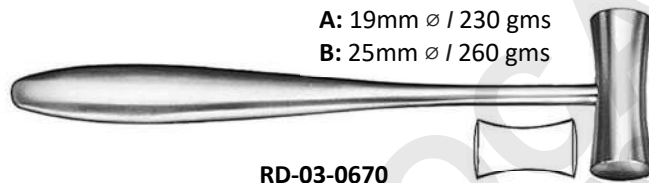

A: 19mm \varnothing / 230 gms
B: 25mm \varnothing / 260 gms

RD-03-0670

Lucae Mallet 19.5 cm / 7 3/4"



RD-03-0671

Cottle Mallet Plane / Convex
19 cm / 7 1/2" 30mm \varnothing / 300 gms



RD-03-0672

Williger Mallet 16.4cm / 6 1/2"
20 mm \varnothing / 140 gms



RD-03-0673

Mallet 26 cm / 10 1/4"
30 mm \varnothing / 510 gms



27mm \varnothing / 320 gms

RD-03-0674

Mead Mallet 19 cm / 7 1/2"
With interchangeable plastic disks



RD-03-0675

Partsch Mallet 19 cm / 7 1/2"
With hollow handle 22mm \varnothing / 200 gms

ORTHOPEDIC MALLETS - S/S & FIBRE



RD-03-0676
Mallet 26 cm / 10 ¼" with lead filling
42mm ø / 400 gms



RD-03-0677
Mallet 26 cm / 10 ¼" without lead filling
42mm ø / 400 gms

- A: 26mm ø / 300 gms
- B: 28mm ø / 340 gms
- C: 30mm ø / 400 gms



RD-03-0678
Williger Mallet 24 cm / 9 ½" lead filled
42mm ø / 400 gms



RD-03-0679
Mallet 30 mm ø / 675 gms
26.5 cm / 10 ½" plane (Teflon) / convex (steel)



RD-03-0680
Mallet 26 cm / 10 ¼"
42 / 30mm ø / 530 gms



RD-03-0681
Mallet 24 cm / 9 ½"
30 mm ø / 480 gms



Spare facings (Pair)



RD-03-0682
Mallet 24 cm / 9 ½"
Disks and handle of Fiber 37 mm ø / 370 gms



RD-03-0683
Mallet 22 cm / 8 ¾"
30 mm ø / 125 gms

- A: 20 .5cm / 8" | 25mm ø / 120 gms
- B: 21cm / 8 ¼" | 30mm ø / 180 gms
- C: 21.5cm / 8 ½" | 35mm ø / 260 gms

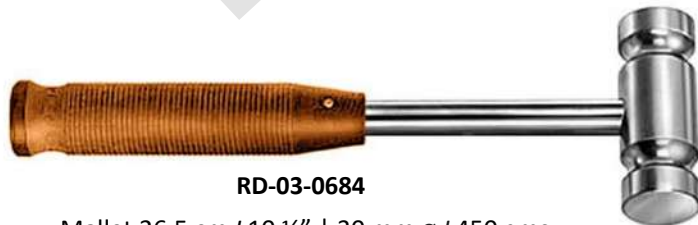

RD-03-0684
Mallet 26.5 cm / 10 ½" | 30 mm ø / 450 gms



RD-03-0685
Doyen Mallet

ELEVATORS SPINAL – S/S & FIBRE



RD-03-0685
Herbert Mallet 19 cm / 7 ½"
For ulnar head prosthesis



RD-03-0686
Collin Mallet 20 cm / 8"
23 mm ø / 220 gms



RD-03-0687
Mallet 26.5 cm / 10 ½"
50 mm ø / 900 gms



Teflon disks
RD-03-0688
Vickers Mallet 19 cm / 7 ½"
25 mm ø / 300 gms



RD-03-0689
Kirk Mallet 20cm / 8"
Head Dia 38mm / Weight: 1 lb. 4 oz. (570 grams)



RD-03-0690
Gerzog Mallet 19 cm / 7 ½"
Head Dia 25mm / Weight 10 oz (285 grams)

Head Weight: 20 oz (567 grams)

Head Weight: 20 oz (567 grams)

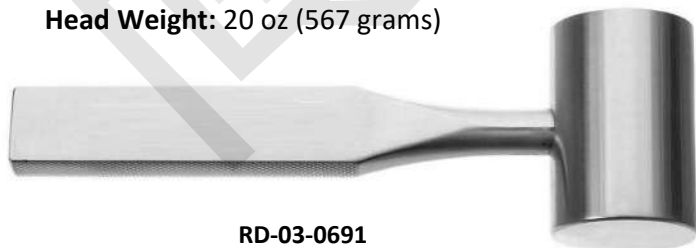

RD-03-0691
Heath Mallet 19 cm / 7 ½"
Head Dia 40mm / Weight 2 lbs. (907gm)



RD-03-0692
Heath Mallet, SS 18 cm / 7" Solid Frame Handle
Head Dia 40mm / Weight 36 oz. (1020gm)

ELEVATORS SPINAL – S/S & FIBRE



RD-03-0694

All Fibre Mallet 24 cm / 9 ½"
Head Dia 80X60mm Weight 14oz. (397gm)



Fibre Handle **RD-03-0695**

Cloward Mallet 19cm / 7 ½"
Head Dia 20mm / Weight 8oz. (227gm)



RD-03-0696

Hajek Mallet 20 cm / 8"
Head Dia 27mm / Weight: 7 oz. (198gm)



Fibre Handle

RD-03-0697

Narrow Tip Mallet 20cm / 8"
Head Dia 7mm Weight 6oz. (170gm)

B: Head Dia 35mm Weight 11b 40 oz. (570gm)
C: Head Dia 40mm Weight 11b 90 oz. (708gm)



RD-03-0698

Fibre Handle Mallet 23cm / 9"
A: Head Dia 30mm / Weight 12 oz. (340gm)



RD-03-0699

He-Man Mallet 28cm / 11"
Head Dia 38mm / 24mm / Weight 21b (906gm)

MENISCUS – TENDON – CARTILAGE INSTRUMENTS

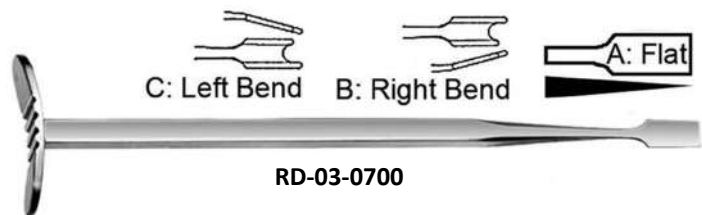

RD-03-0700

Smillie Meniscus Knife 18 cm / 7"



RD-03-0701

Meniscus Knife 18 cm / 7"

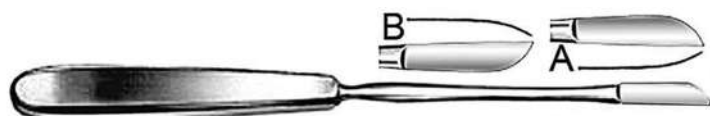

RD-03-0702

Neff Meniscus Knife 22 cm / 8 3/4"



RD-03-0703

Salenius Meniscus Knife 21 cm / 8 1/4" A: Right / B: Left



RD-03-0704

Bunnell Tendon Stripper 15 cm / 6"



RD-03-0705

Fischer Tendon Stripper 31 cm / 12 1/4" Blunt



RD-03-0706

Tendon Passing Instrument 33.5 cm / 13 1/4"



RD-03-0707

Fischer Tendon Stripper 31 cm / 12 1/4" Blunt



RD-03-0708

Tendon Stripper 3 / 4 / 5 / 6mm
A: 28.5 cm / 11 1/4" B: 60 cm / 24"



RD-03-0709

Bunnell Tendon Passer 23 cm / 9" Malleable



RD-03-0710

Downing Cartilage Knife 25 cm / 10"
Concave Edge Cvd Blade w/ Guards



RD-03-0711

Lowe Breck Cartilage Knife 25cm/10" STR Edge-Cvd Blade w / Guards



RD-03-0712

Tendon Stripper 40 cm / 16" Fibre Handle

TENDON INSTRUMENTS



Cvd Serrated Blades

RD-03-0713

Martin Cartilage Scissors 20cm / 8"

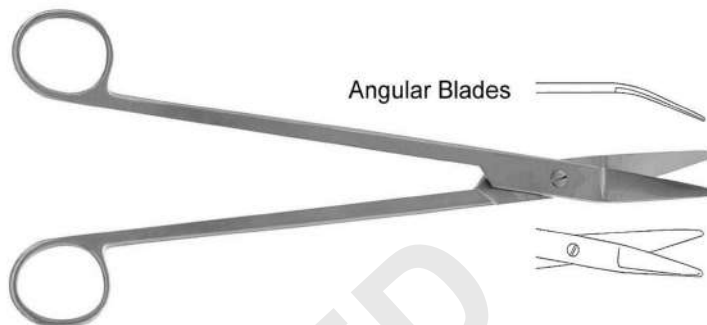

Angular Blades

RD-03-0714

Mueller Capsule Scissors 24 cm / 9 1/2"

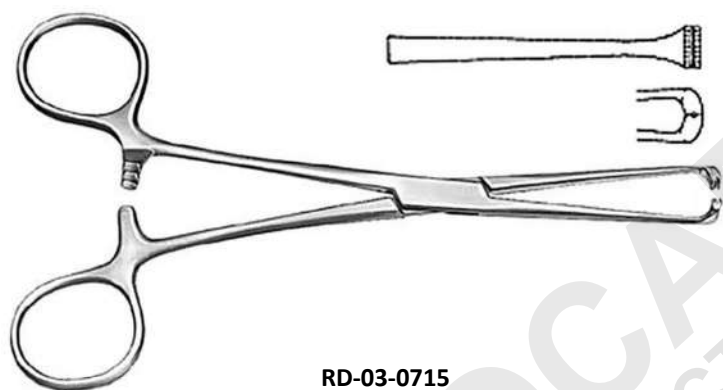

RD-03-0715

Steinmann Tendon Holding Forceps 16 cm / 6 1/4"

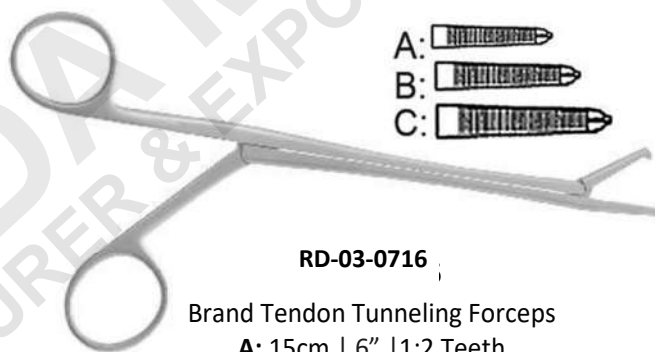

A:
B:
C:

RD-03-0716

Brand Tendon Tunneling Forceps

A: 15cm | 6" | 1:2 Teeth

B: 19cm | 7 1/2" | 1:2 Teeth

C: 24.5cm | 9 3/4" | 1:2 Teeth

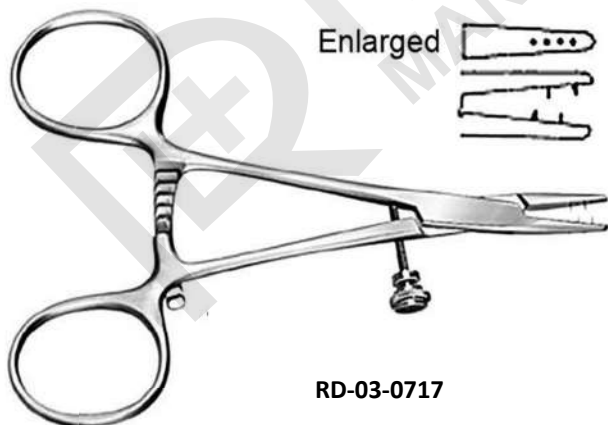

Enlarged

RD-03-0717

Tendon Holding Forceps

11.5cm / 4 1/2"

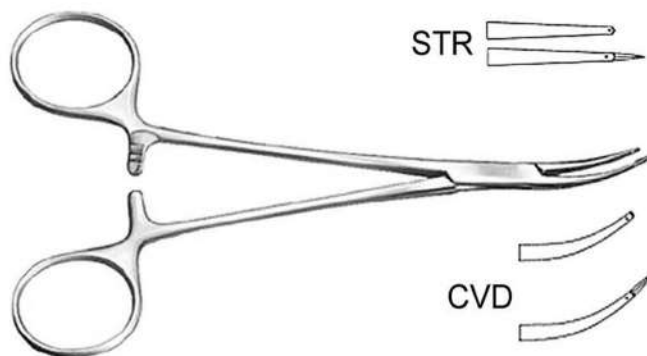

STR

CVD

RD-03-0718

Tendon Interlacing Forceps

15.5 cm / 6" Pointed

TENDON INSTRUMENTS



RD-03-0719-1

Carroll Tendon Holding Forceps
11.5 cm / 4 1/2"

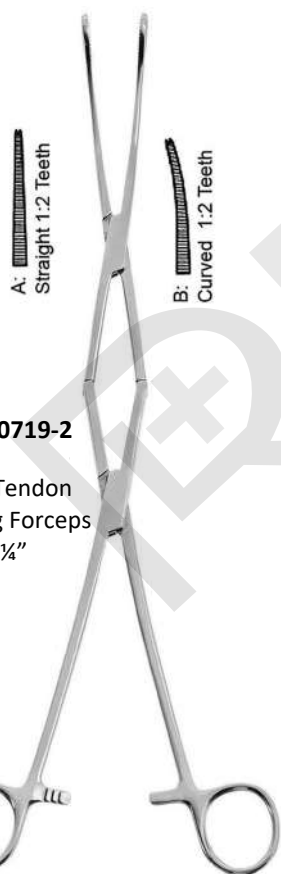

A: Straight 1:2 Teeth

B: Curved 1:2 Teeth

RD-03-0719-2

Hallman Tendon Tunneling Forceps
21 cm / 8 1/4"

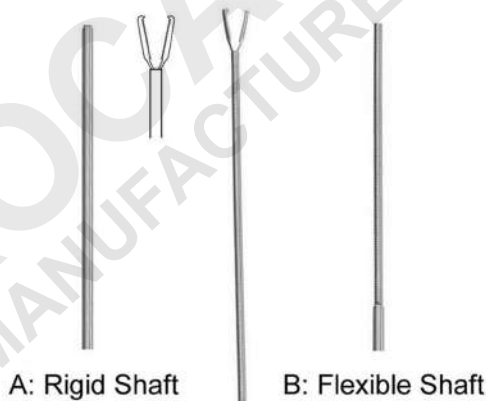

A: Rigid Shaft

B: Flexible Shaft

RD-03-0720

Kleinert-Kutz Tendon Holding Forceps
21 cm / 8 1/4"
1X2teeth

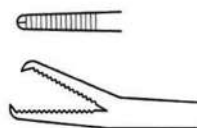

RD-03-0721

Hoen Grasping Forceps
14 cm / 5 1/2" (Shaft)
1X2 teeth

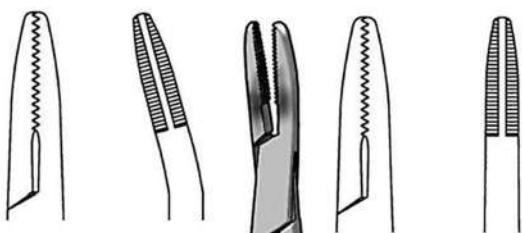

Serrated Jaw
Angled 20°

Serrated Jaw
Straight

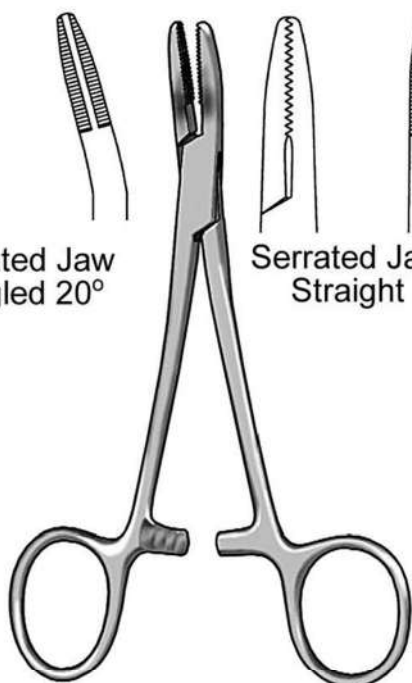

RD-03-0722
Meniscus Clamp
13.5 cm / 5 3/8" 1X2 teeth

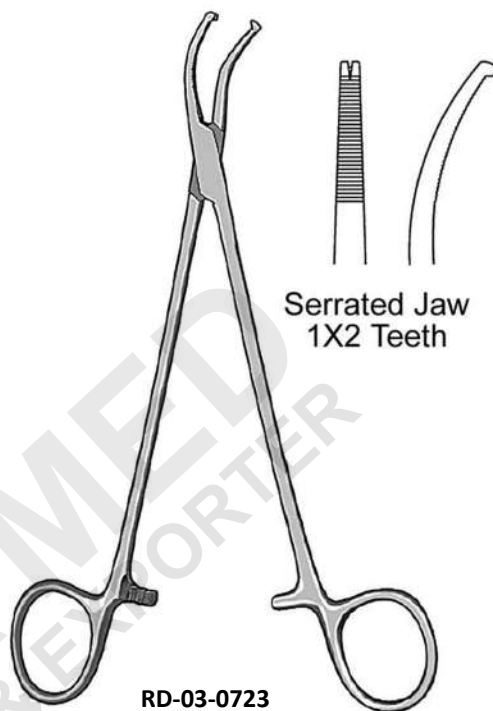

Serrated Jaw
1X2 Teeth

RD-03-0723
Preston Ligamentum Flavum Forceps
(Meniscus) 18.5 cm / 7 1/4"



Straight

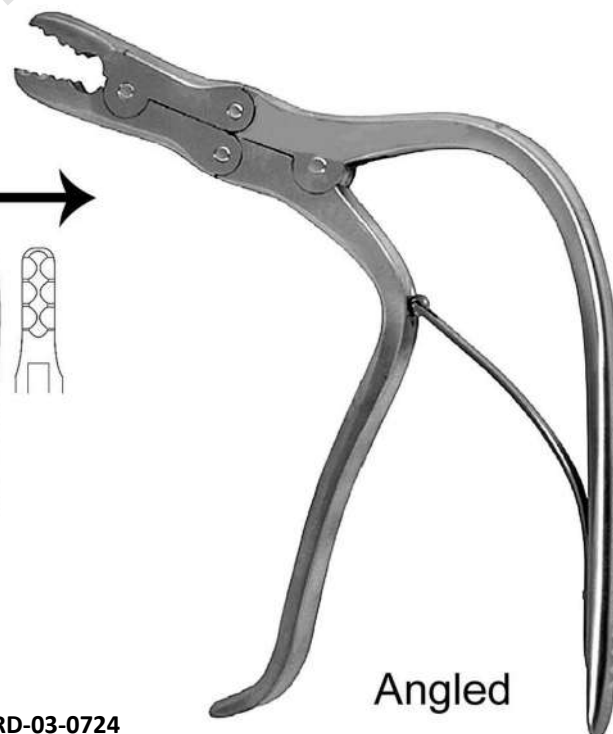
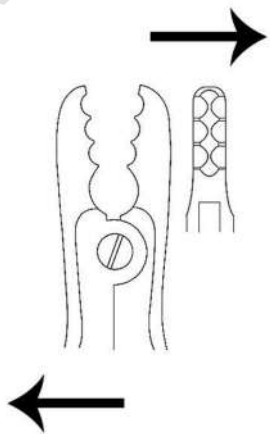

Angled

RD-03-0724
Ortho Grasper 21 cm / 8 1/2"
7 X 20 MM Bite

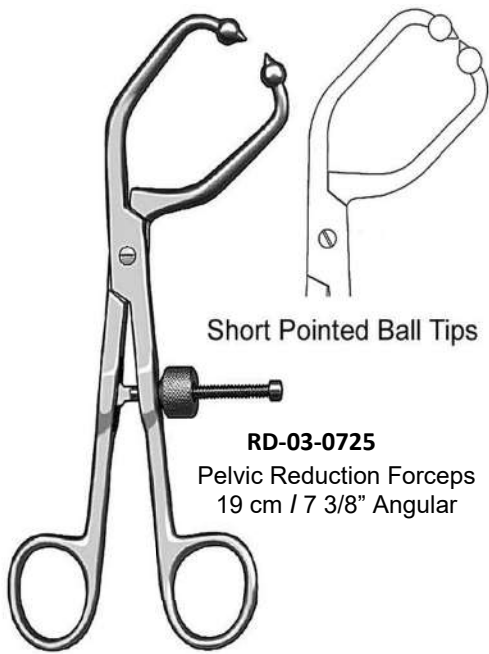

Short Pointed Ball Tips

RD-03-0725
Pelvic Reduction Forceps
19 cm / 7 3/8" Angular

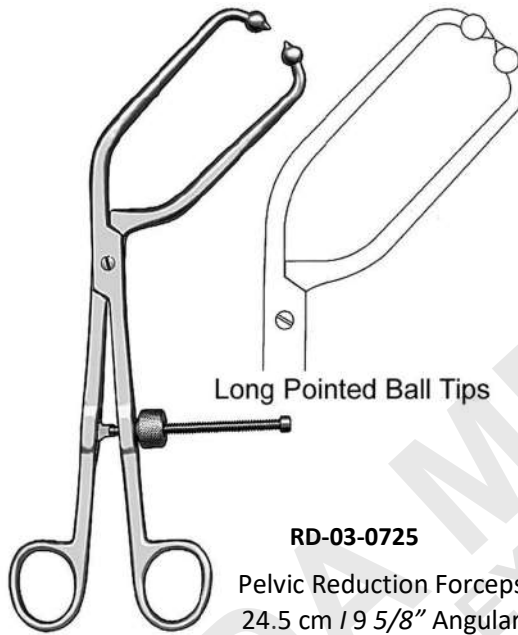

Long Pointed Ball Tips

RD-03-0725
Pelvic Reduction Forceps
24.5 cm / 9 5/8" Angular

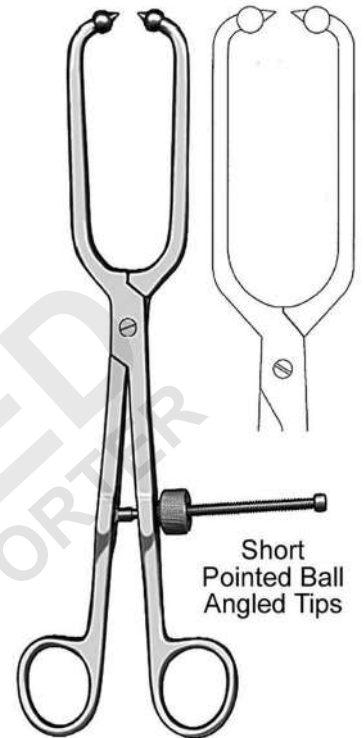

Short Pointed Ball Angled Tips

RD-03-0727

Pelvic Reduction Forceps
25 cm / 10"



Long Pointed Ball Tips

RD-03-0728
Pelvic Reduction Forceps
Available in 2 Sizes
A: 24 cm / 9 1/2"
B: 41cm / 16"

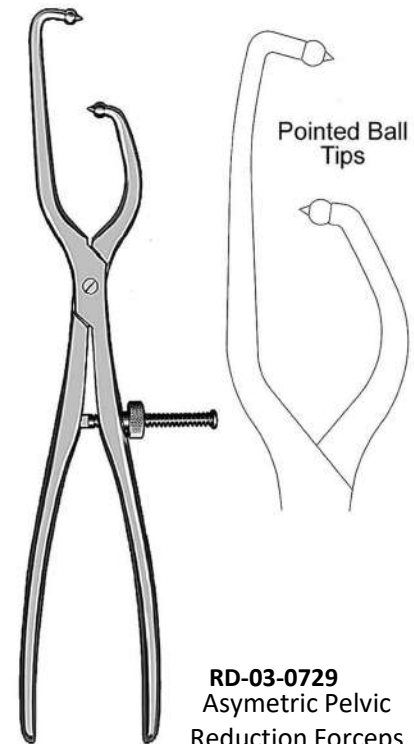

Pointed Ball Tips

RD-03-0729
Asymmetric Pelvic Reduction Forceps
41 cm / 16"

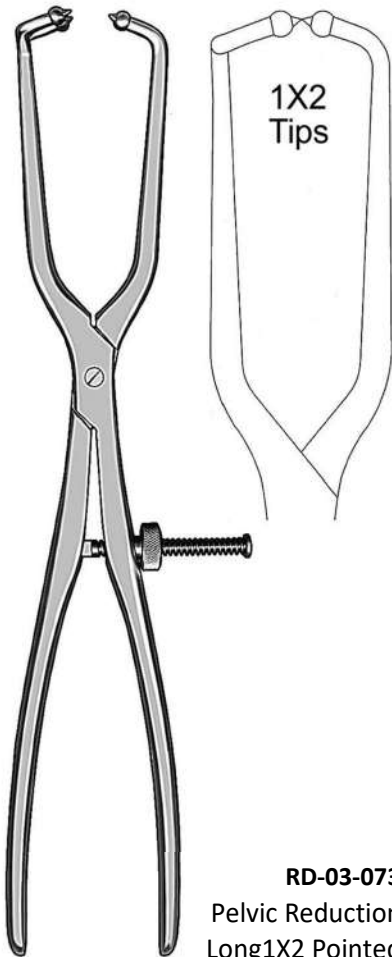

RD-03-0730
Pelvic Reduction Forceps
Long 1X2 Pointed Ball Tips
41 cm / 16"

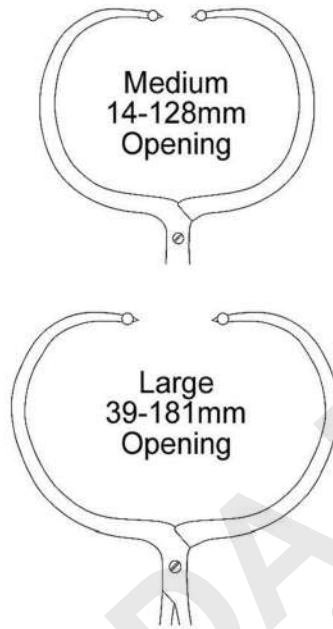

RD-03-0731
Periarticular Reduction Forceps
Straight / Pointed Ball Tips
38 cm / 15"



RD-03-0732
Pelvic Reduction Forceps
Adjustable Jaws for Screws
A: 25 cm / 10" B: 33 cm / 13"

BONE HOLDING FORCEPS

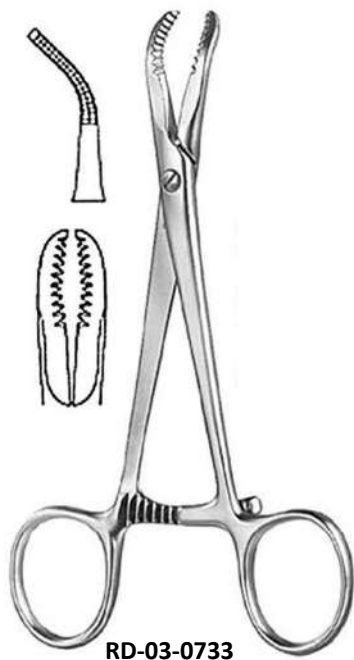

RD-03-0733

Bone Holding Forceps
14 cm / 5 1/2"

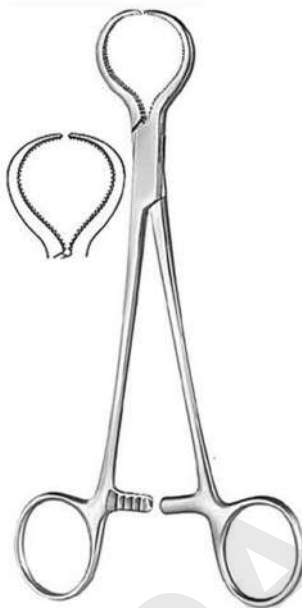

RD-03-0734

Lewin Bone Holding Forceps
18.5 cm / 7 1/4"

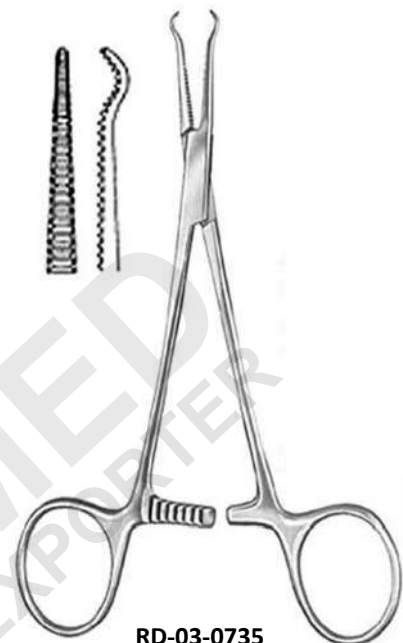

RD-03-0735

Bone Holding Forceps
14 cm / 5 1/2" Delicate



RD-03-0736

Frosch Bone Holding Forceps 18 cm / 7"



RD-03-0737

Bone Holding Forceps 20 cm / 8"



RD-03-0738

Semb Bone Holding Forceps 19 cm / 7 1/2"



RD-03-0739

Lengenbeck Bone Holding Forceps 21 cm / 8 1/4"

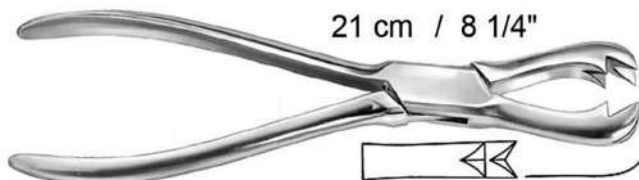

RD-03-0740

Fergusson Bone Holding Forceps Heavy pattern



RD-03-0741 A: 23 cm / 9" B: 26 cm / 10 1/4"

Farabeuf Bone Holding Forceps

BONE HOLDING FORCEPS



RD-03-0742

Kern Bone Holding Forceps

A: 17 cm / 6 ¾"

B: 21 cm / 8 ¼"

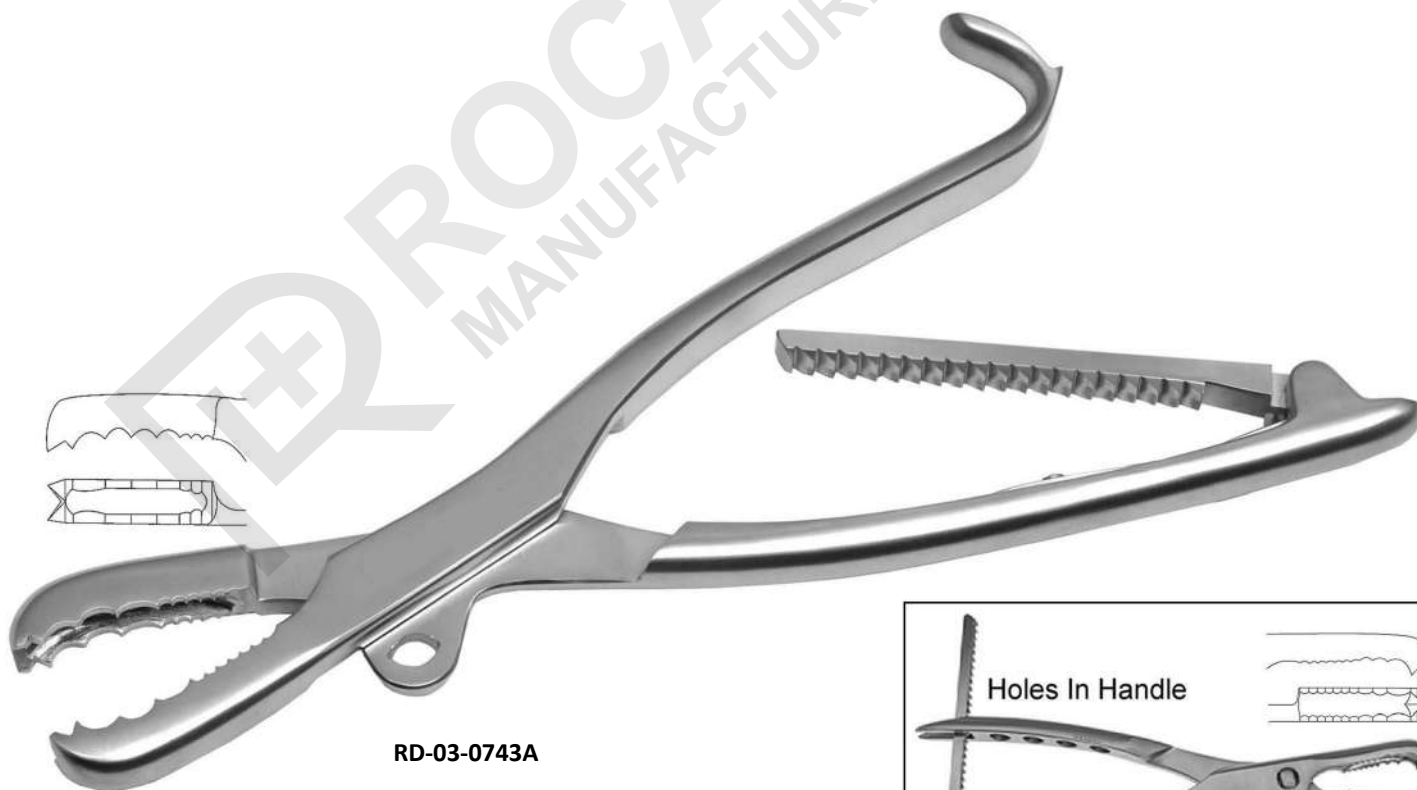

RD-03-0743A

Farabeuf Lambotte Bone Holding Forceps

A: 23 cm / 9" | **B:** 26 cm / 10"

Adjustable / with Ratchet



RD-03-0743B

BONE HOLDING FORCEPS

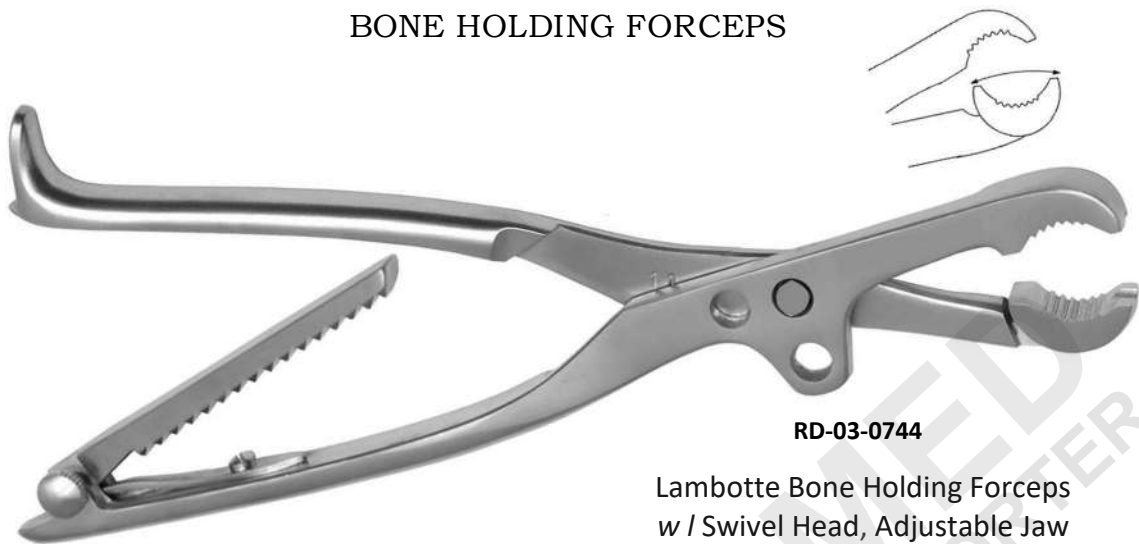

RD-03-0744

Lambotte Bone Holding Forceps
w / Swivel Head, Adjustable Jaw

A: 22 cm | 8 ¾" | **B:** 27 cm | 10 ¾" | **C:** 30 cm | 11 ¾"



RD-03-0745

Ulrich Bone Holding Forceps
w / Thread Fixation 19 cm / 7 ¼"

RD-03-0746

Ulrich Bone Holding Forceps
w / Thread Fixation

A: 23 cm / 9" | **B:** 25 cm / 9 ¾" | **C:** 28 cm / 11"

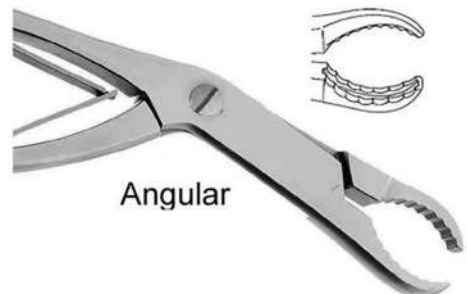

Angular

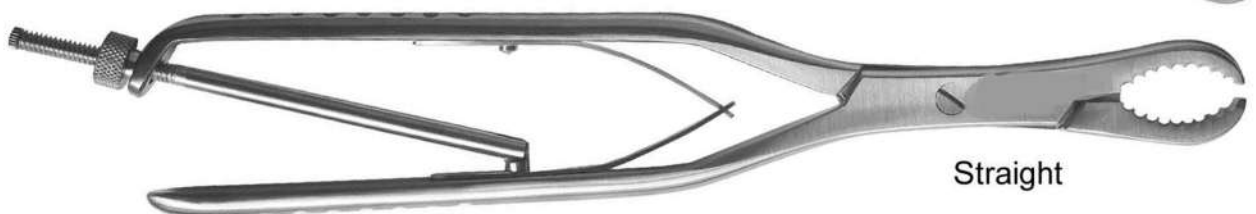

Straight

BONE HOLDING FORCEPS

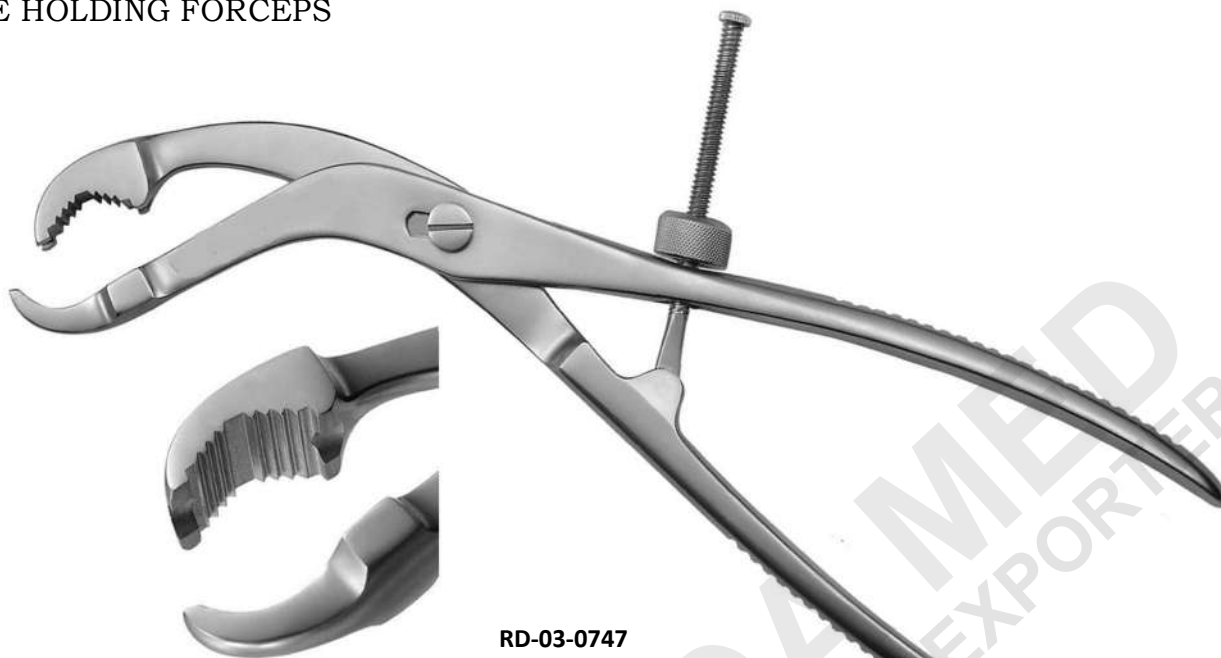

RD-03-0747

Self-Centering Bone Holding Forceps
W/ Thread Fixation

A: 15 cm / 6" | B: 19 cm / 17 1/2" | C: 24 cm / 9 1/2"

D: 26 cm / 10 1/4" | E: 28 cm / 11"

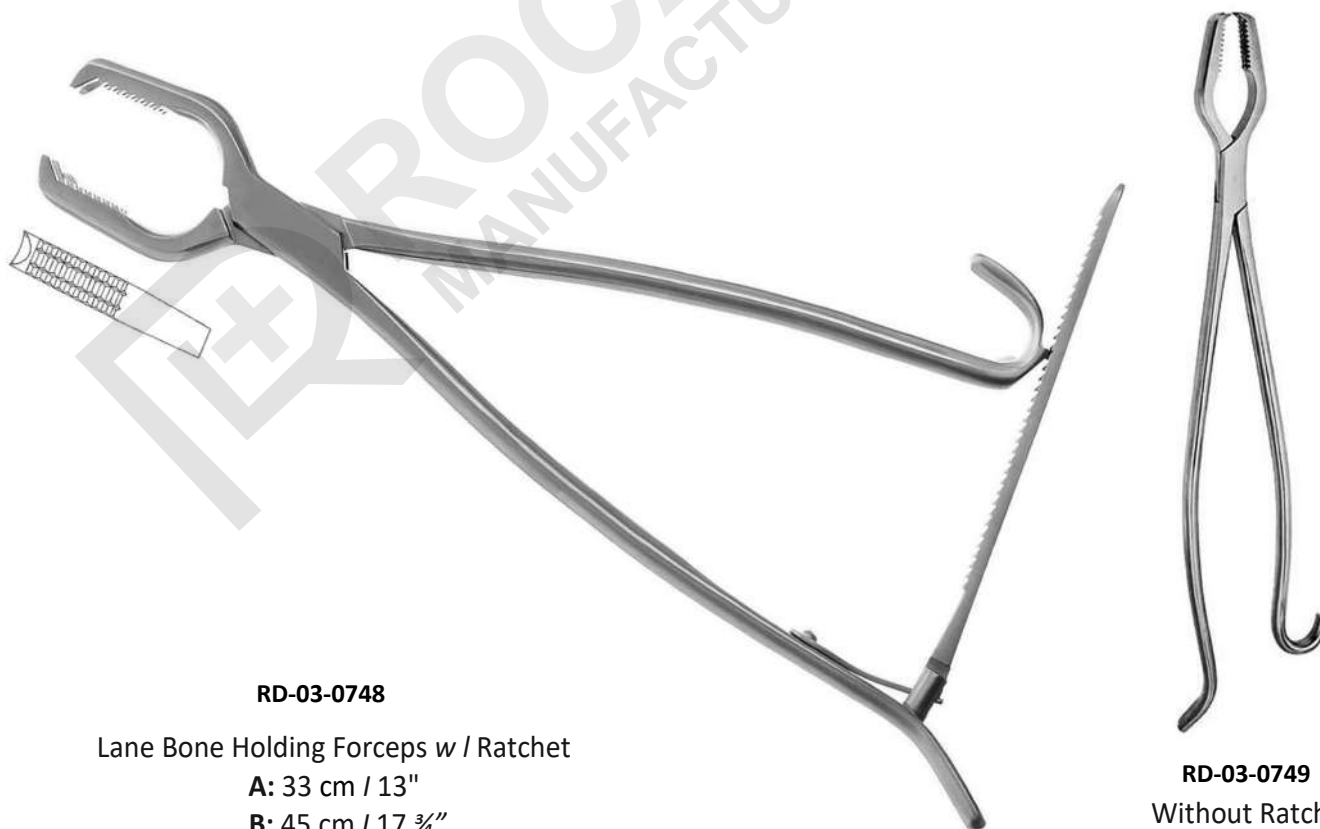

RD-03-0748

Lane Bone Holding Forceps w / Ratchet

A: 33 cm / 13"

B: 45 cm / 17 3/4"

RD-03-0749

Without Ratchet

BONE HOLDING FORCEPS



RD-03-0750

Hey Groves Bone Holding Forceps
A: 20 cm / 8" | B: 25 cm / 10" | C: 30 cm / 12"



RD-03-0751

Verbrugge Bone Holding Forceps
A: 17.5 cm / 7" | B: 25 cm / 9 3/4"
C: 26 cm / 10 1/4" | D: 27 cm / 10 3/4"



RD-03-0752

Smooth Jaws Bone Holding Forceps
23 cm / 9"

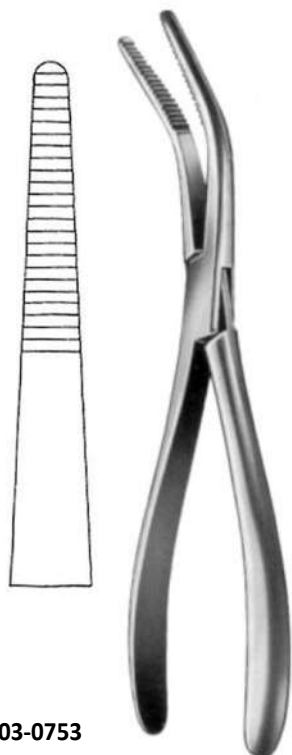

RD-03-0753

Van Buren Bone Holding Forceps
21.5 cm / 8 1/2"

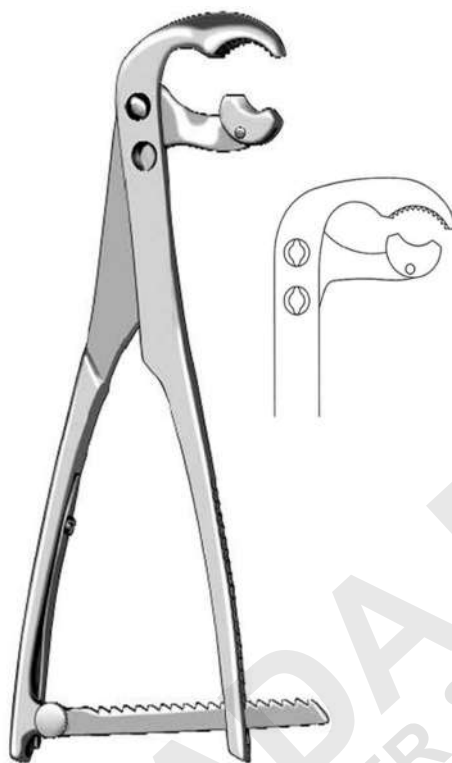

RD-03-0754

Angled Bone Holding Forceps 23 cm / 9"

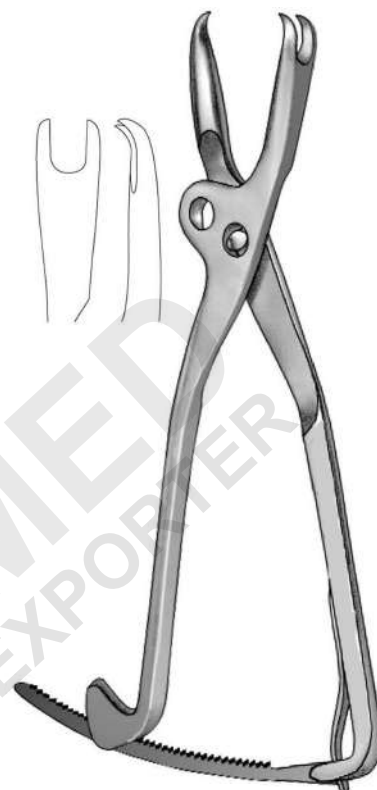

RD-03-0755

Bishop Bone Holding Forceps 23 cm / 9"



RD-03-0756

Bone Holding Forceps
A: 17cm 6 3/4" 0.9mm
B: 13cm 5 1/4" 1.6mm

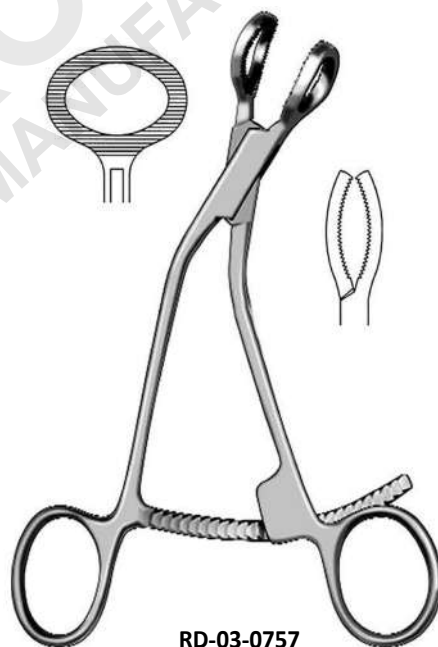

RD-03-0757

Bishop Bone Holding Forceps
23 cm / 9"

1X2 Prong



2X2 Prong

RD-03-0758

Patella Forceps 18 cm / 7"

BONE HOLDING FORCEPS

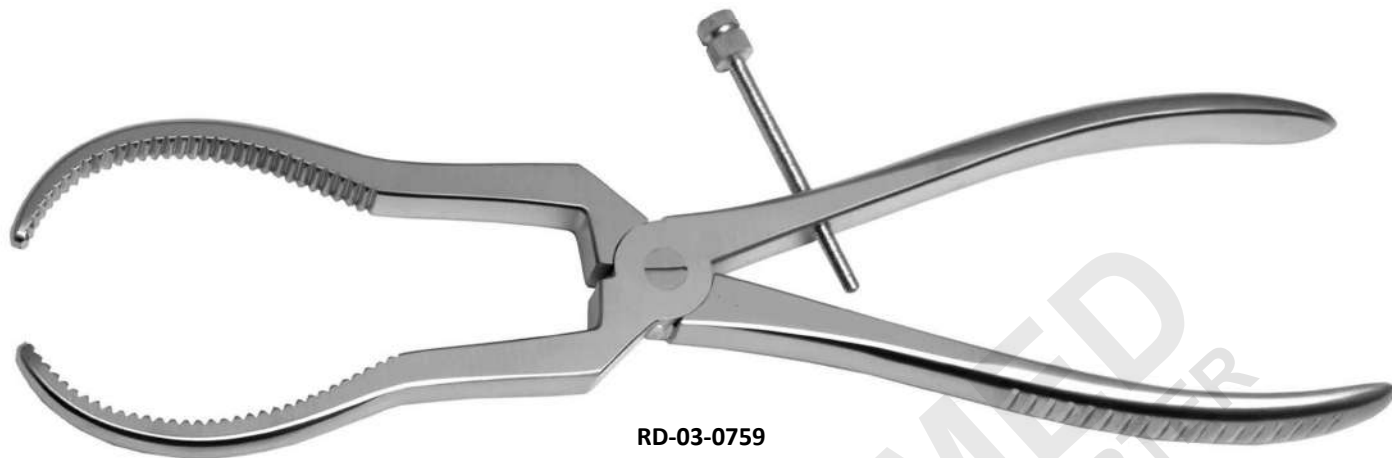

RD-03-0759

Hayton Williams Forward Traction Forceps
Broad Tips 23 cm / 9"



RD-03-0760

Fibula Bone Holding Forceps
21 cm / 8 ½"



RD-03-0762

Semb Bone Holding Forceps
Curved Sideward
21 cm / 8 ½"



RD-03-0761

Bone Holding Forceps
w/ Thread Fixation
15 cm / 6"



Small Large

RD-03-0762-2
Bargo Bone Holding Forceps 15 cm / 6"



RD-03-0763
Martin Cartilage Seizing Forceps
18.5 cm / 7 1/4"

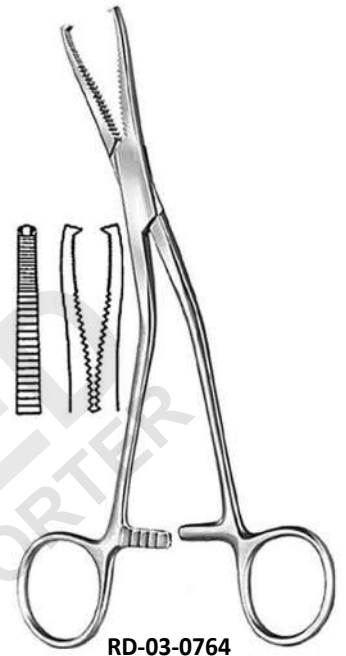

RD-03-0764
Dingmann Cartilage Seizing Forceps
18.5 cm / 7 1/4"



RD-03-0765
Reposition Forceps
13.5 cm / 5 1/4" Long ratchet pointed



RD-03-0766
Reposition Forceps
15 cm / 6" Long Ratchet Pointed

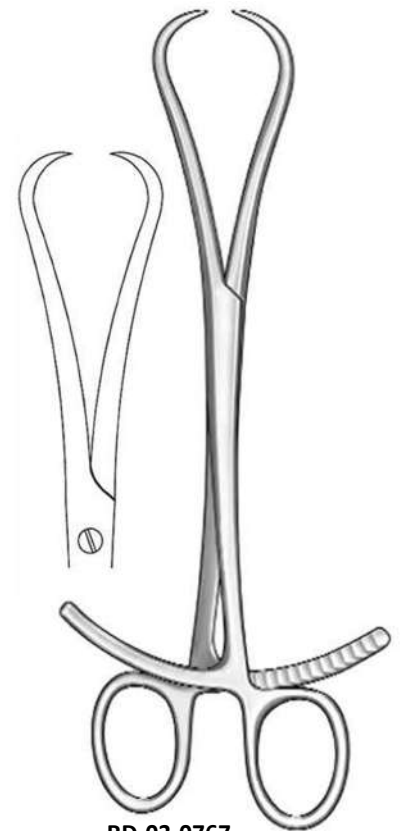

RD-03-0767
Walton Bone Reduction Forceps
20.5 cm / 8" | 2" Double Ratchet
Opening 9-100mm

REPOSITION – CARTILAGE FORCEPS

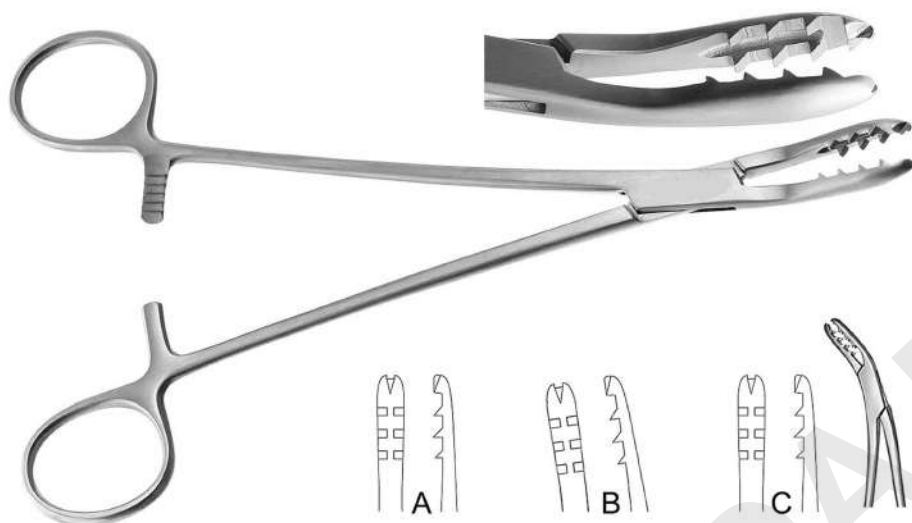

RD-03-0768

Cartilage Seizing Forceps

A: Straight | B: Upward Cvd | C: Sideward Cvd

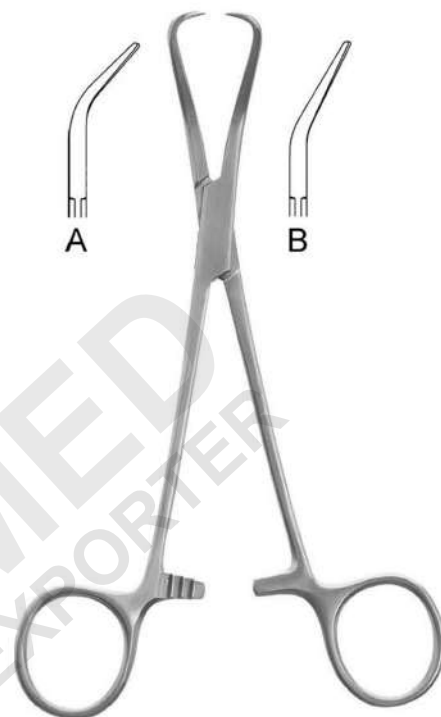

RD-03-0769

Glenoid Perforating Forceps 17cm / 6 1/2"

A: Strong Cvd | B: Slight Cvd



RD-03-0770

Bone Reposition Forceps
w / Thread Fixations Screw

A: 17 cm / 6 3/4"

B: 24 cm / 9 1/2"

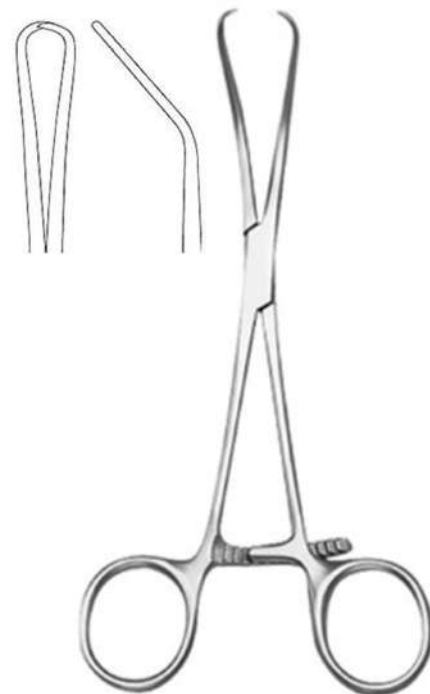

RD-03-0771

BONE CUTTING FORCEPS

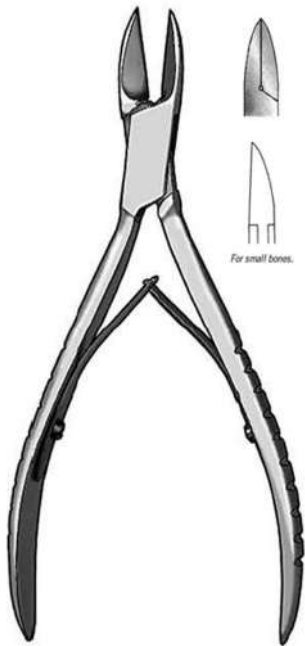

RD-03-0772
Littauer Bone Cutting Forceps
15 cm / 6"



RD-03-0773
Marwalder Bone Nipper
18.5 cm / 7 1/4"



RD-03-0774
Cottle Kazanjian Bone Cutting
Forceps 18.5 cm / 7 1/4"

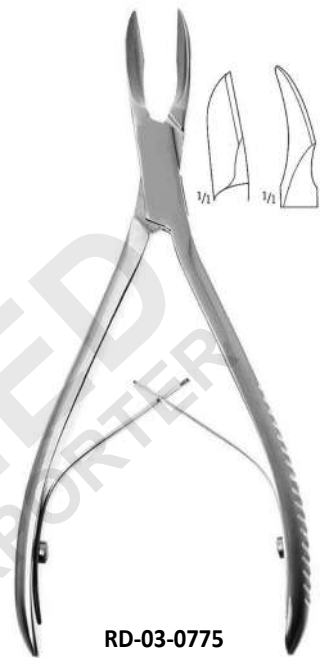

RD-03-0775
Cleveland Bone Cutting Forceps
A: 14.5 cm / 5 3/4"
B: 17 cm / 6 3/4"



RD-03-0776
Liston Bone Cutting Forceps

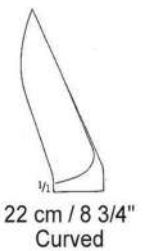
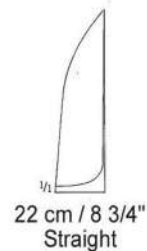
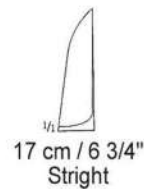
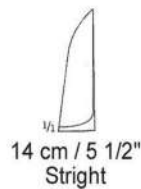

BONE CUTTING FORCEPS



RD-03-0777

Kleinert-Kutz / Bohler Bone Cutting Forceps 14.5 cm / 5 3/4"

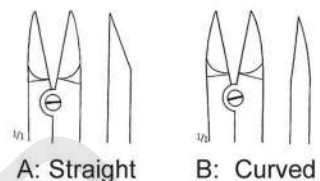

A: Straight

B: Curved

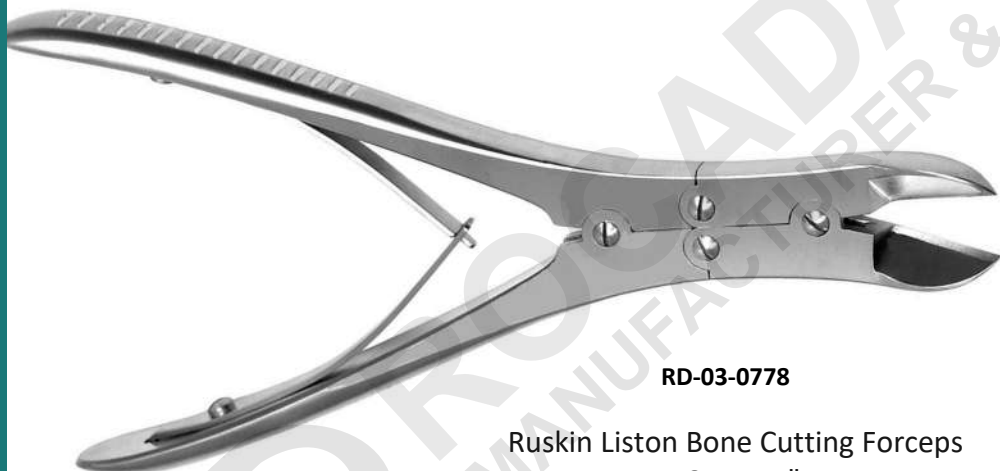

RD-03-0778

Ruskin Liston Bone Cutting Forceps 18 cm / 7"

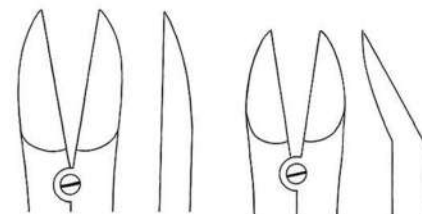

A: Straight

B: Curved



RD-03-0779

Stille-Liston Bone Cutting Forceps 26 cm / 10 1/4"

90°Angle

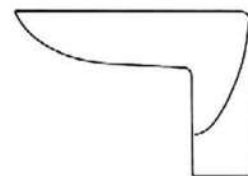

BONE CUTTING FORCEPS



RD-03-0780

Stille-Liston Bone Cutting Forceps
A: 23 cm / 9" | B: 27.5 cm / 10 3/4"

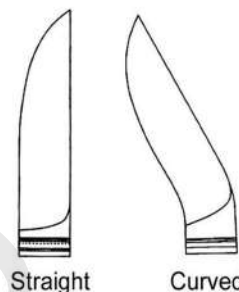

Straight

Curved



RD-03-0781

Cleveland Bone Cutting Forceps
16 cm / 6 1/4"



RD-03-0782

Me Indoe Bone Cutting Forceps
18 cm / 7" Delicate Blades

BONE CUTTING FORCEPS

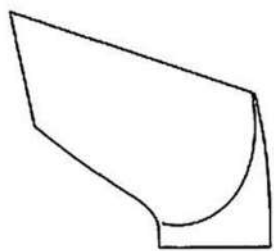

45° Angled



RD-03-0783

Stille-Horsley / Liston Key Bone Cutting Forceps
25.5 cm / 10"

90° Angled

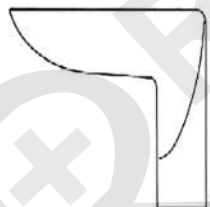

Angled On Side

RD-03-0784

Semb Bone Cutting Forceps
24.5 cm / 9 3/4"

BONGE RONGEURS - NIBBLERS

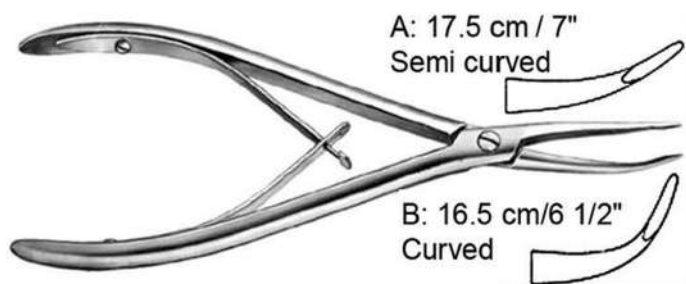

RD-03-0785
Stellbrink Bone Rongeur



RD-03-0786
Friedmann Bone Rongeur
A: 12.5 cm / 5" | B: 13.5 cm / 5 1/4"



RD-03-0787
Friedmann Bone Rongeur
13.5 cm / 5 1/4"



RD-03-0788
Cleveland Bone Rongeur
A: 13.5 cm / 5 1/4" | B: 16.5 cm / 6 1/2"



RD-03-0789
Mead Bone Rongeur 16.5 cm / 6 1/2"

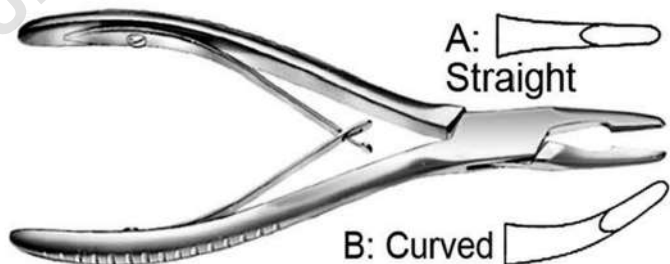

RD-03-0790
Jansen Bone Rongeur 18 cm / 7"



RD-03-0791-1
Luer Bone Rongeur 14.5 cm / 5 3/4"

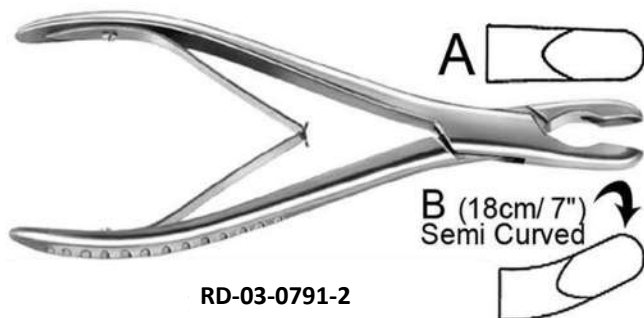

RD-03-0791-2
Luer Bone Rongeur 18.5 cm / 7 1/4"

BONGE RONGEURS - NIBBLERS

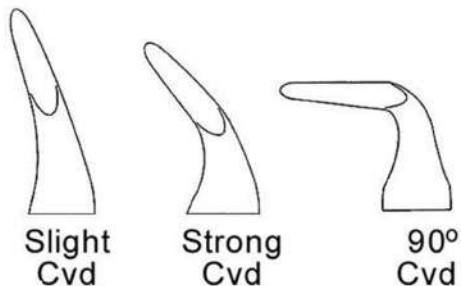

RD-03-0792

Blumental Bone Rongeur 12.5 cm / 5"



RD-03-0793

Hartmann Bone Rongeur 17.5 cm / 7"



RD-03-0794

Jansen Bone Rongeur 19 cm / 7 1/2" Bayonet



RD-03-0795
Jansen Bone Rongeur Straight
A: 14 cm / 5 1/2"
B: 17 cm / 6 1/2"



RD-03-0796
Jansen Bone Rongeur Delicate
14 cm / 5 1/2"

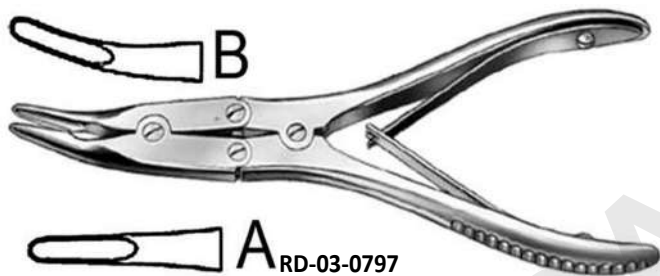

RD-03-0797
Bohler Bone Rongeur 15.5 cm / 6"

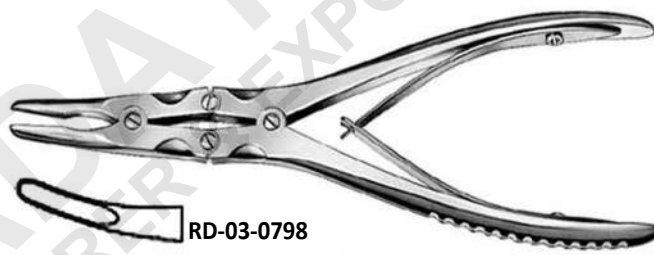

RD-03-0798
Beyer Bone Rongeur 18 cm / 7"



RD-03-0799
Zaufai-Jansen Bone Rongeur 18 cm / 7"



RD-03-0800
Mayfield Bone Rongeur 18 cm / 7"



RD-03-0801
Marquard Bone Rongeur 20.5 cm / 8"

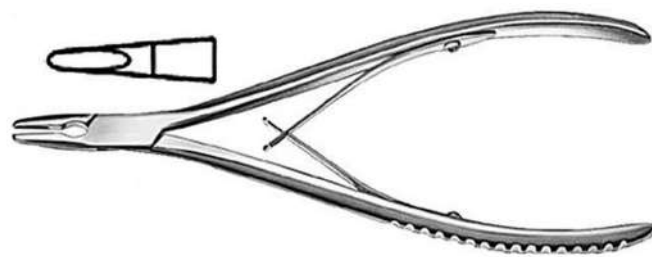

RD-03-0802
Lempert Bone Rongeur 19 cm / 7 1/2"

BONGE RONGEURS - NIBBLERS



RD-03-0803
Stille Bone Rongeur
22.5 cm / 8 ¾"

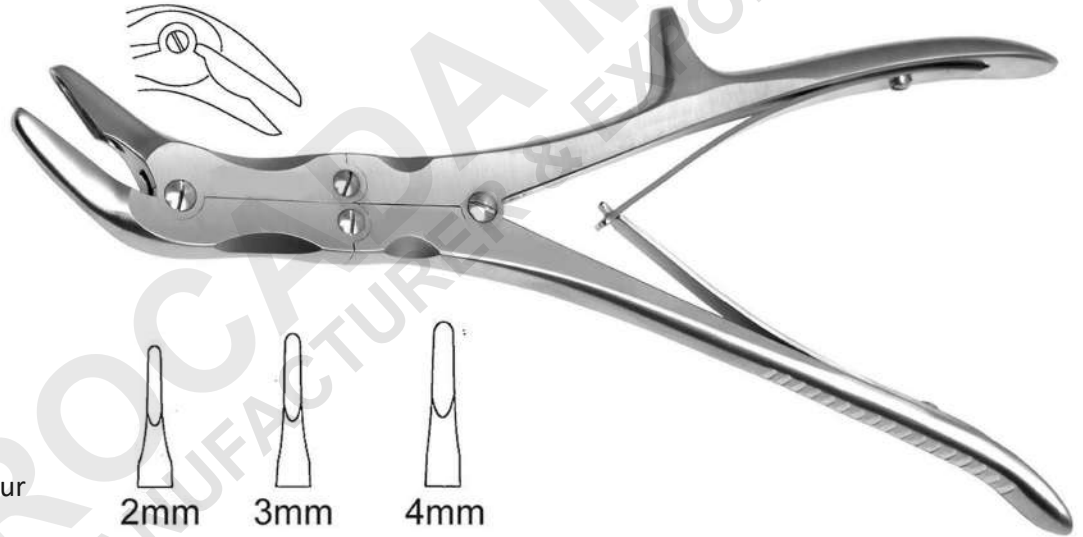

RD-03-0804
Echlin Duckbill Bone Rongeur
22 cm / 8 ¾"

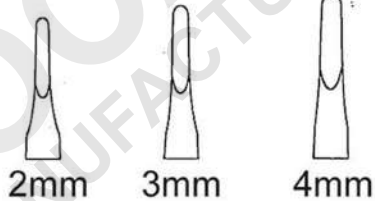

RD-03-0805
Ruskin Bone Rongeur
18 cm / 7"



BONGE RONGEURS - NIBBLERS



RD-03-0806

Ruskin Bone Rongeur
24 cm / 9 1/2"

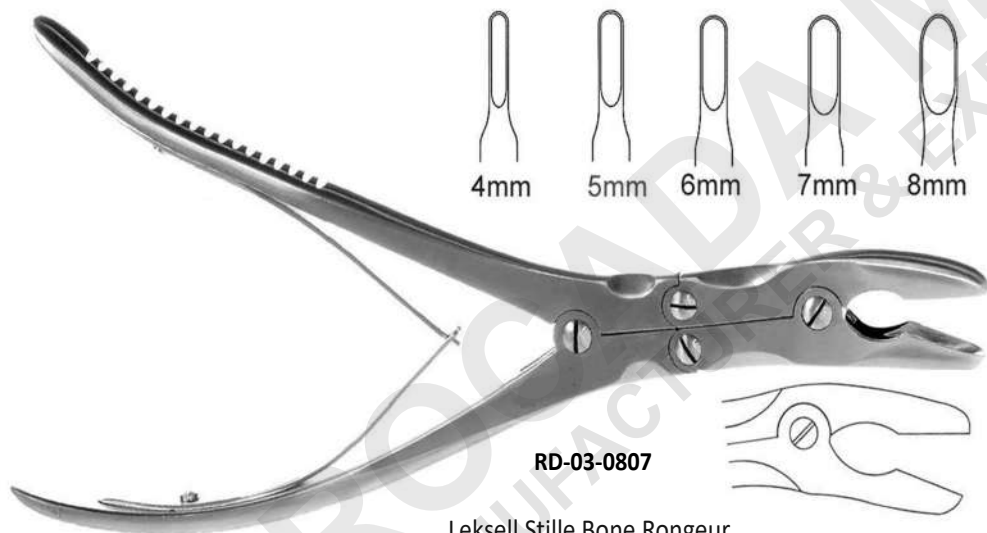

RD-03-0807

Leksell Stille Bone Rongeur
24 cm / 9 1/2"

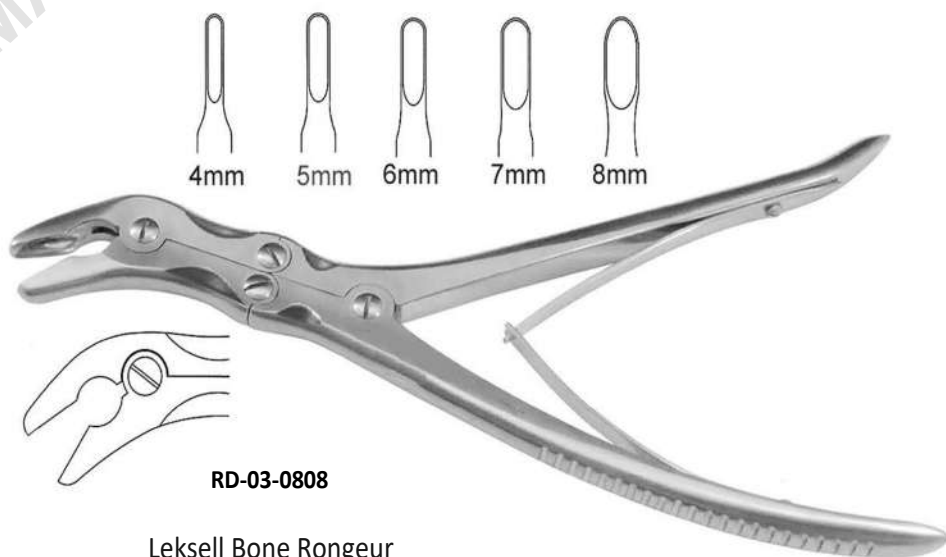

RD-03-0808

Leksell Bone Rongeur
24 cm / 9 1/2"

BONGE RONGEURS - NIBBLERS



RD-03-0809

Leksell Bone Rongeur
23 cm / 9"

- A: Straight
- B: Slight Curved
- C: Strong Curved
- D: Extra Strong Cvd

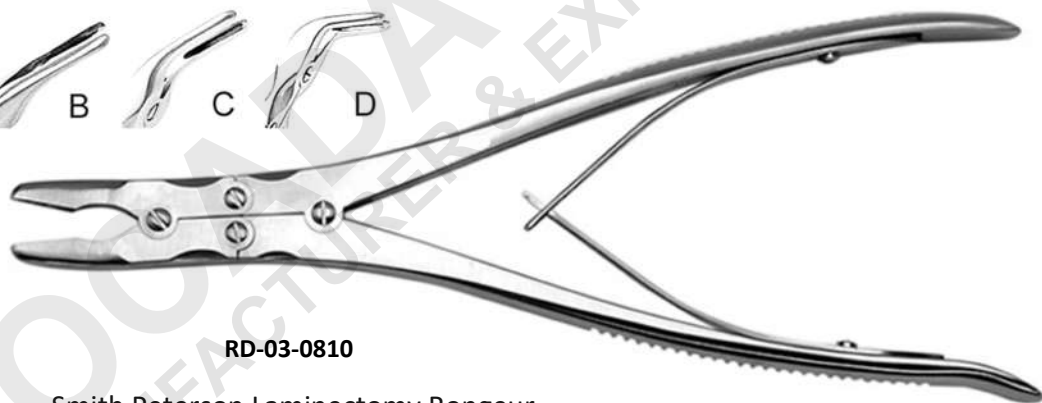

RD-03-0810

Smith Peterson Laminectomy Rongeur
24 cm / 9 1/2"

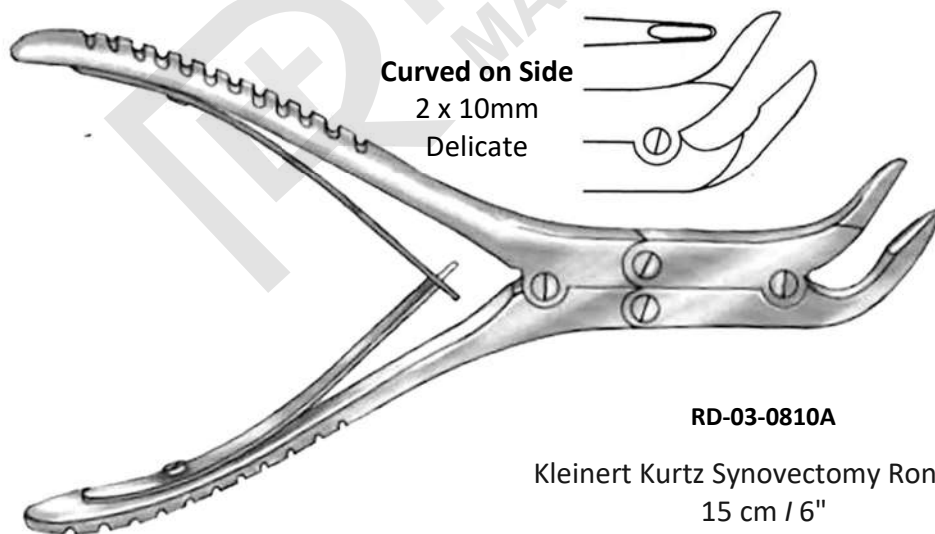

Curved on Side
2 x 10mm
Delicate

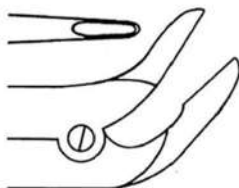

RD-03-0810A

Kleinert Kurtz Synovectomy Rongeur
15 cm / 6"

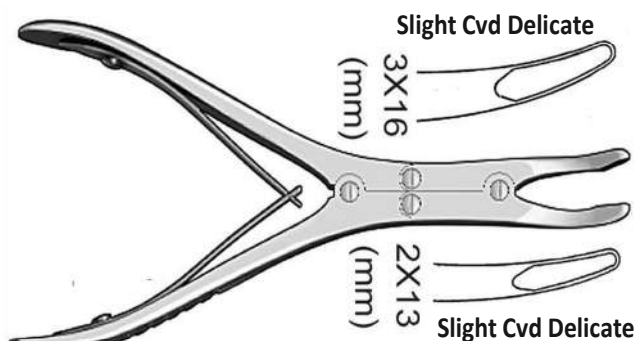

RD-03-0810B

Kleinert Kurtz Synovectomy Rongeur 15 cm / 6"

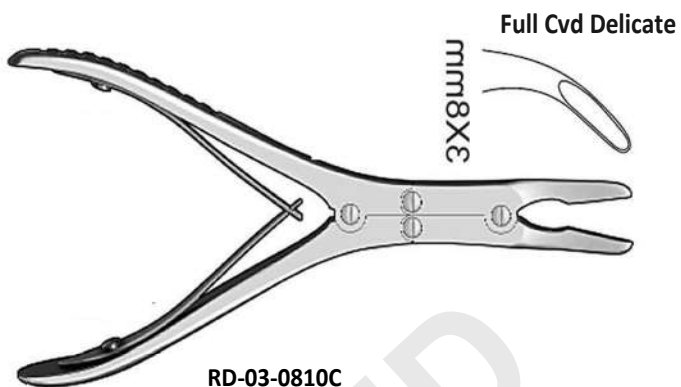

RD-03-0810C

Kleinert Kurtz Synovectomy Rongeur 15 cm / 6"

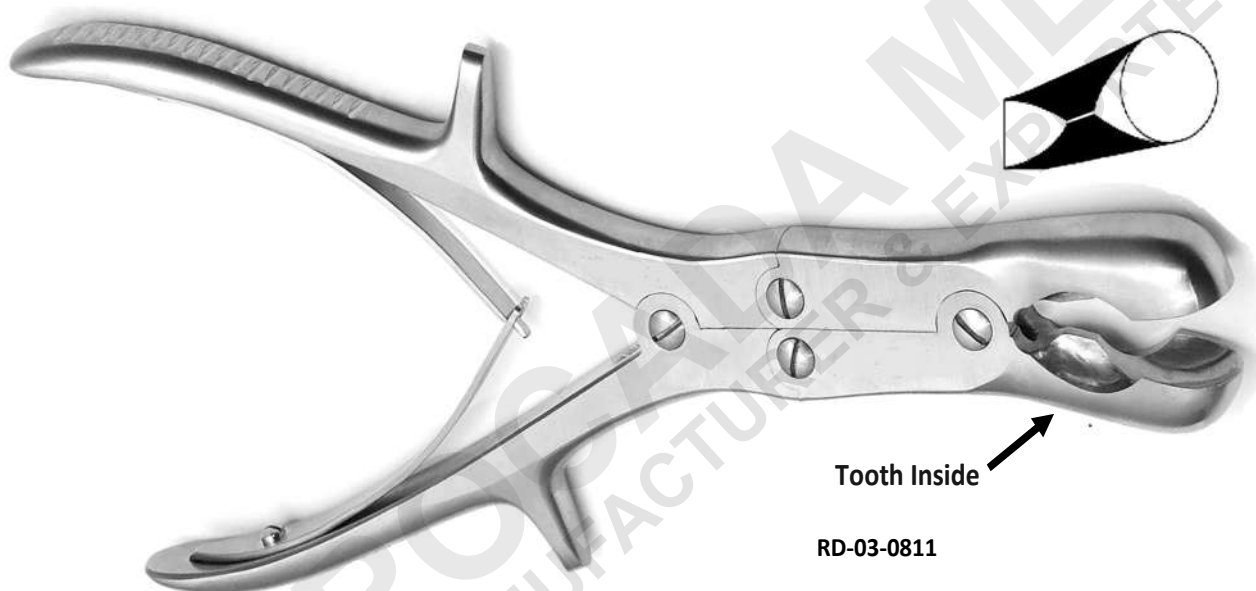

RD-03-0811

Semb Bone Rongeur 23.5 cm / 9 1/4"

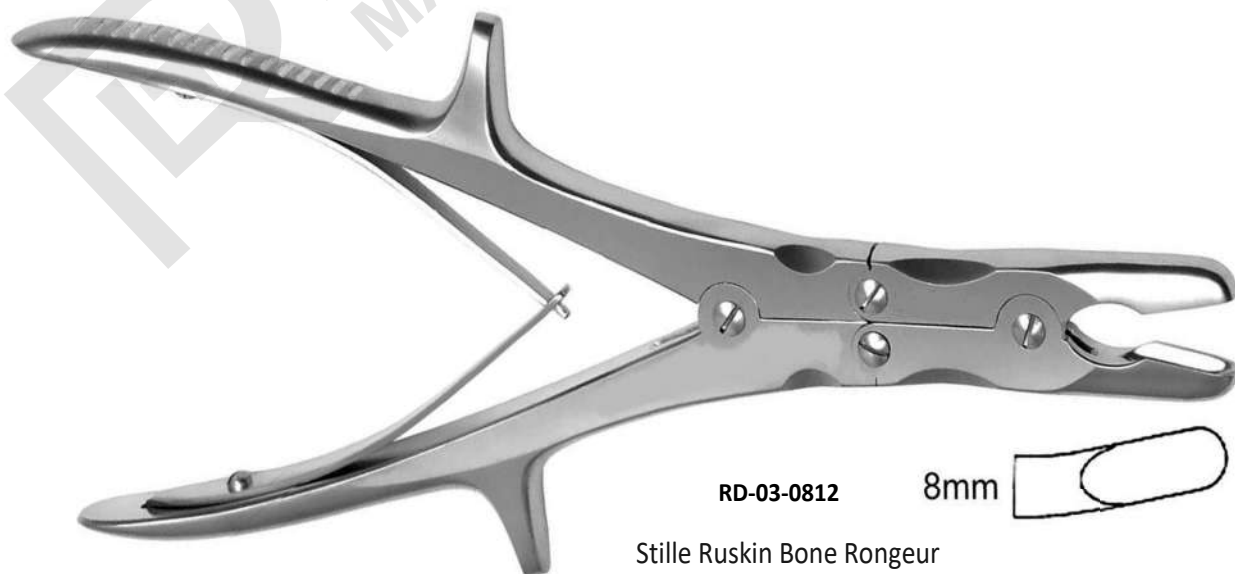

RD-03-0812

Stille Ruskin Bone Rongeur
23.5 cm / 9 1/4"

BONGE RONGEURS - NIBBLERS

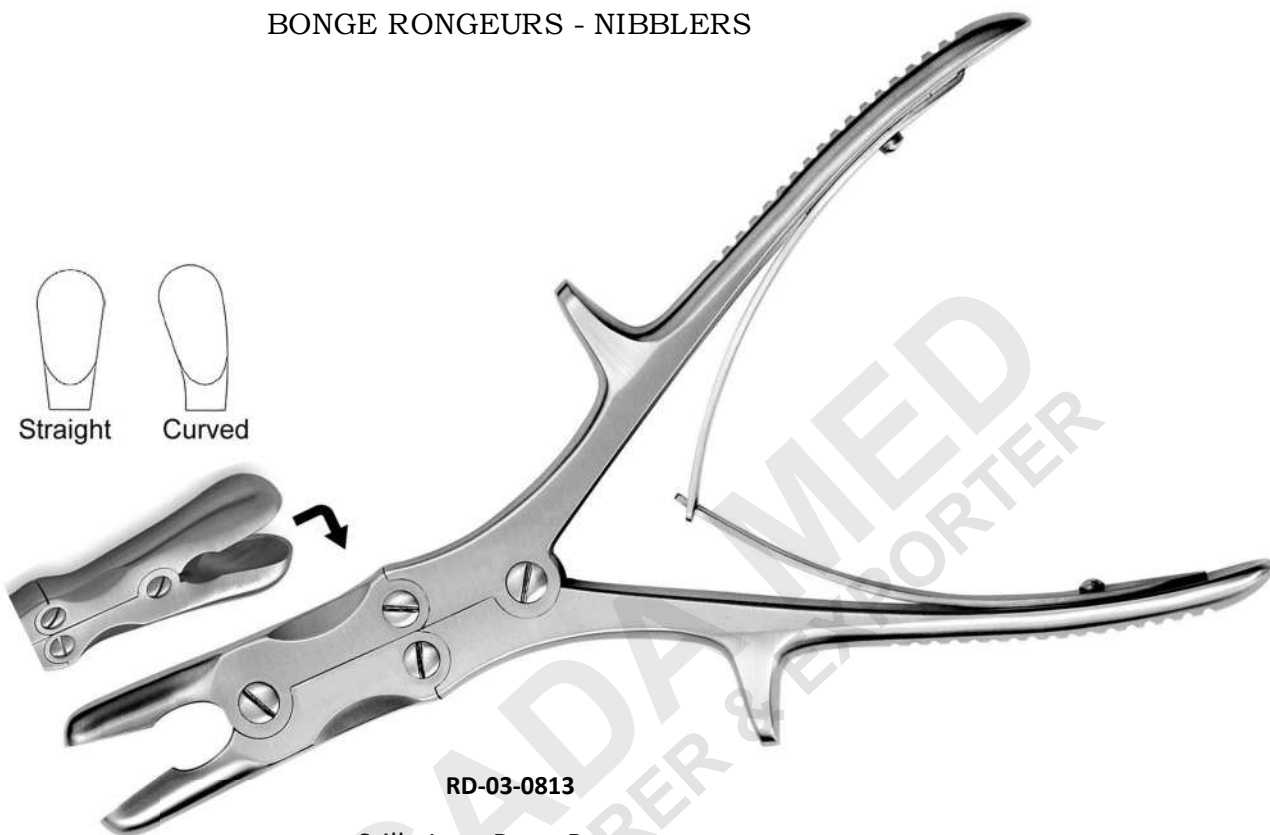
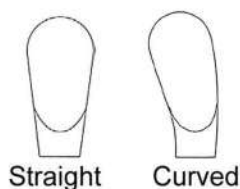

RD-03-0813

Stille Luer Bone Rongeur
26.5 cm / 10 1/2"

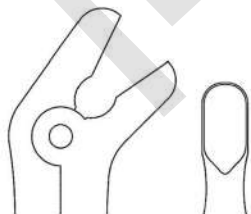
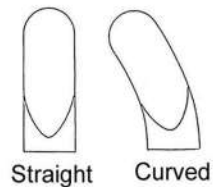
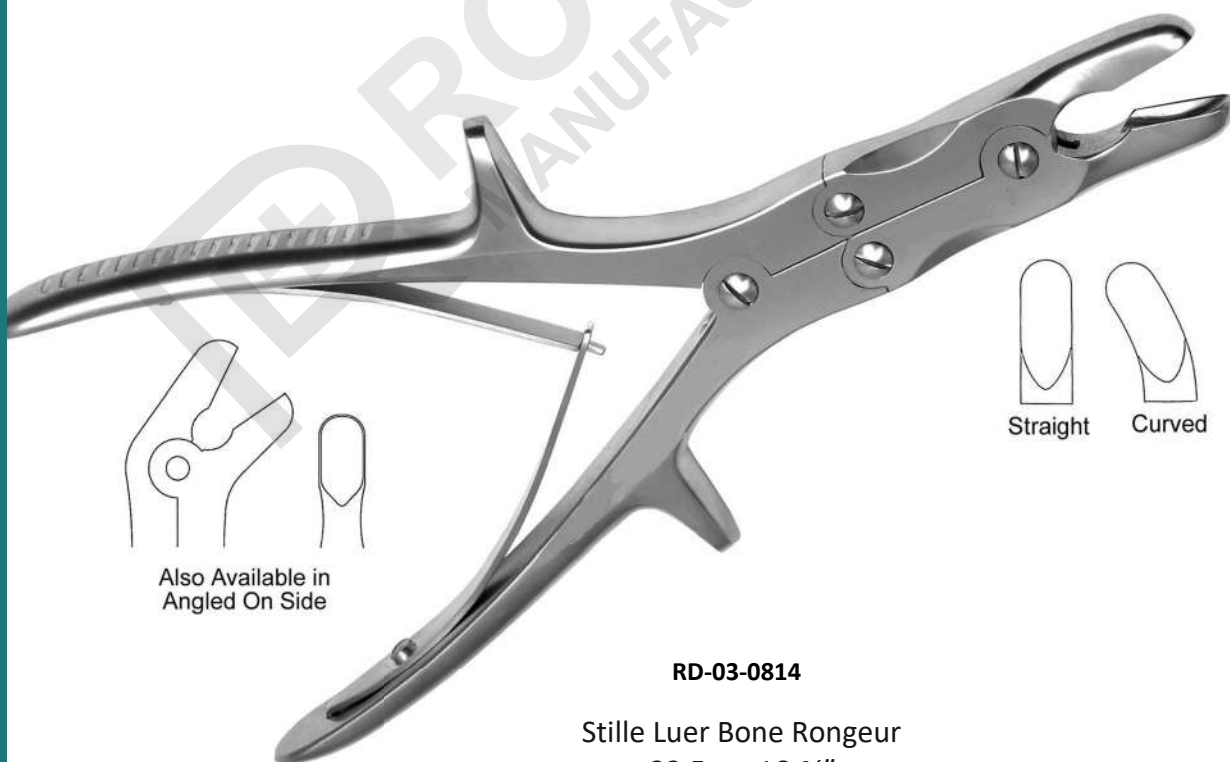

Also Available in
Angled On Side

RD-03-0814

Stille Luer Bone Rongeur
22.5 cm / 8 3/4"

A: 3mm
B: 5mm
C: 8mm



RD-03-0815
Mainz Long Neck Bone Rongeur
18 cm / 7"



RD-03-0816
Leksell Bayonet Rongeur
41 cm / 16"



RD-03-0817
Syfert Rongeur 37 cm / 14 1/2"

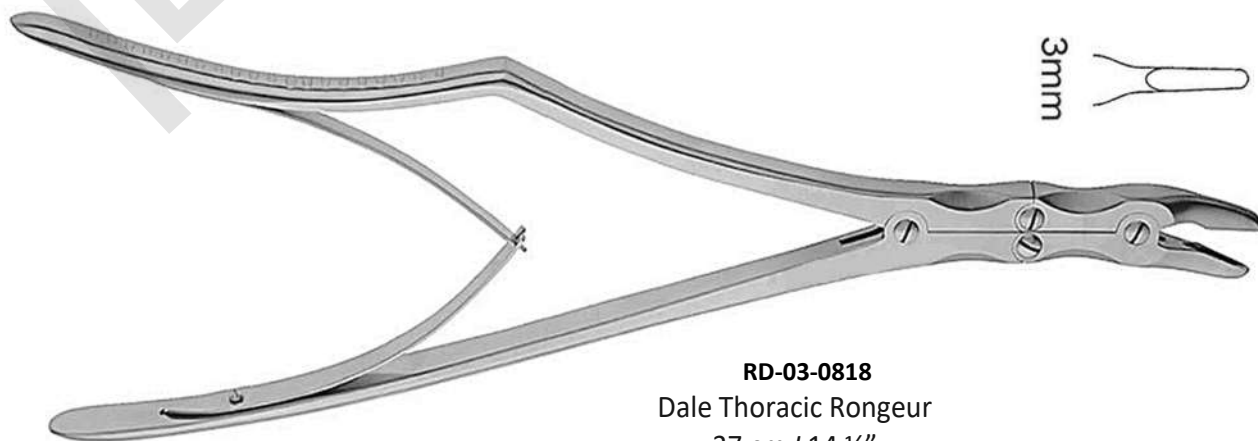

RD-03-0818
Dale Thoracic Rongeur
37 cm / 14 1/2"

BONGE RONGEURS - NIBBLERS

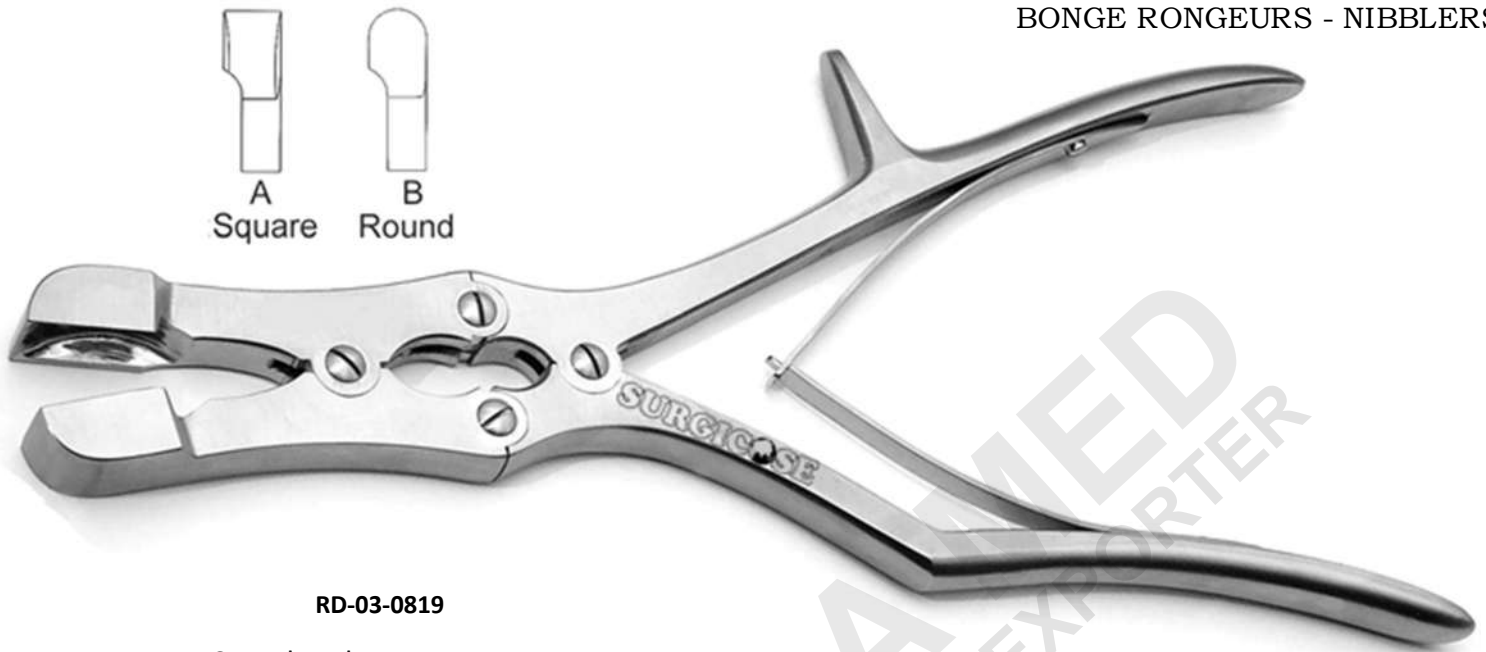

RD-03-0819

Sauerbruch Bone Rongeur
37 cm / 14 1/2"

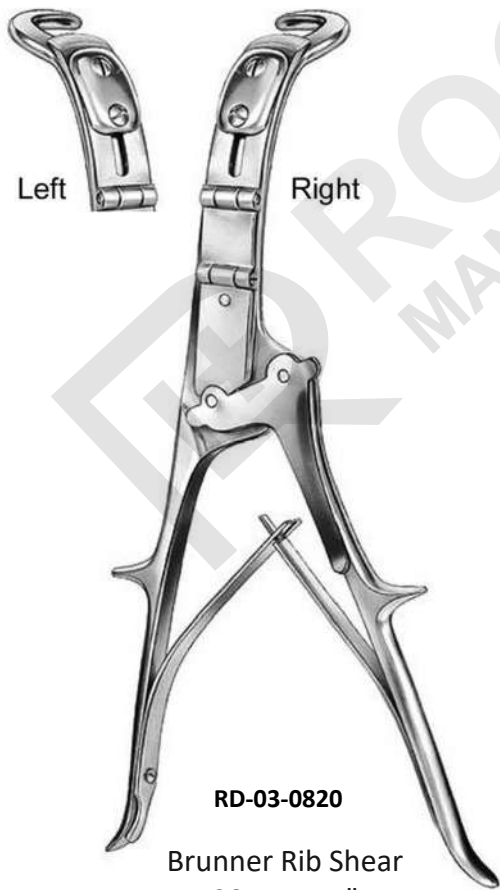

RD-03-0820

Brunner Rib Shear
28 cm / 11"



RD-03-0821

Sauerbruch Rib Shear
A: 23 cm / 9" | B: 26 cm / 10 1/4"

RIB SHEARS



RD-03-0822
Giertz Stille Rib Shear
25 cm / 10"



RD-03-0828
Gluck Rib Shear
A: 16 cm / 6"
B: 18 cm / 7"
C: 20 cm / 8"
D: 23 cm / 9"



RD-03-0823
Rib Shear Double Spring 22 cm / 8 3/4"

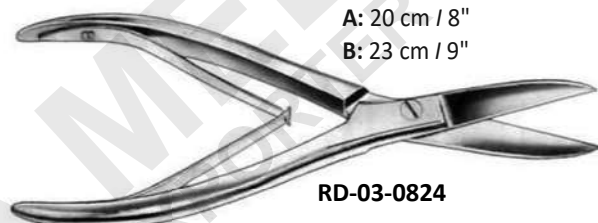

A: 20 cm / 8"
B: 23 cm / 9"
RD-03-0824
Rib Shear Double Spring

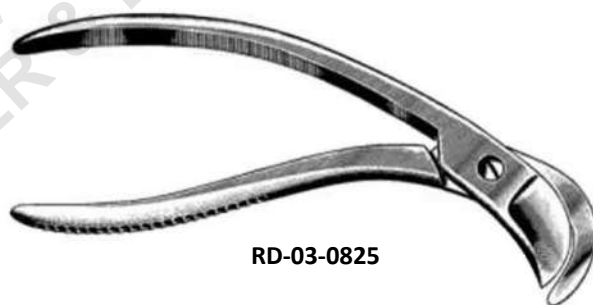

RD-03-0825
Collin Rib Shear 17.5 cm / 7"

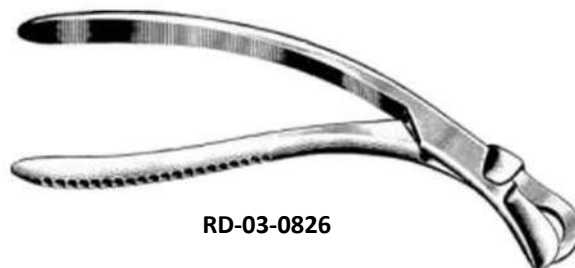

RD-03-0826
Collin Rib Shear 17 cm / 6 3/4"



RD-03-0827
Stille Rib Shear 21 cm / 8 1/4"

RIB SHEARS



RD-03-0829

Labsche Rib Shear 25 cm / 10"

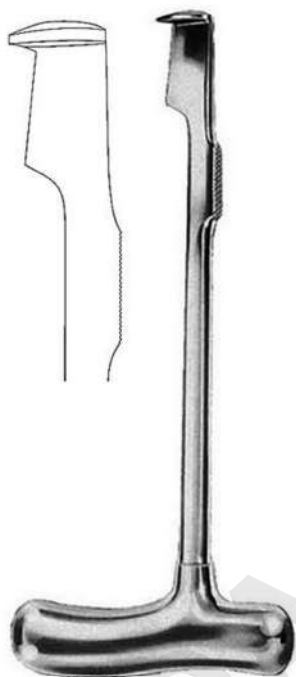

RD-03-0830

T Handle Labsehe Sternum Chisel
24 cm / 9 1/2"



RD-03-0831

Rib Shear Sideward 17 cm / 6 3/4"



Pointed
Tips

RD-03-0832B

Bethune Rib Shear
S Shaped Handle
34 cm / 13 1/2"



RD-03-0832A

Bethune Rib Shear
S Shaped Handle
34 cm / 13 1/2"

RIB SHEARS



RD-03-0833

Coryllos-Bethune Rib Shear
S Shaped Handle
35 cm | 13 ½"

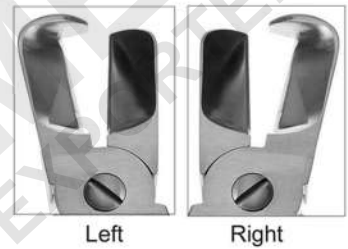

Left

Right



RD-03-0834

Roos Rib Shear
Right Angled Jaw W/ Hook
33 cm / 13"



LAMINA SPREADERS - RETRACTORS

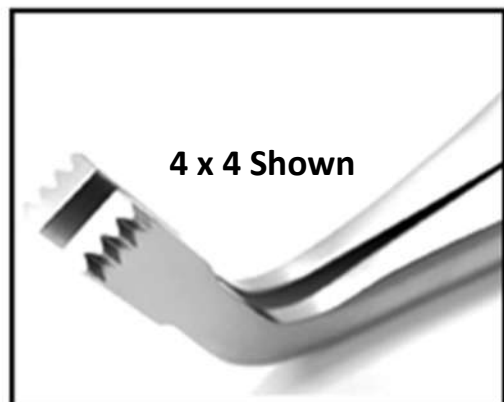

4 x 4 Shown

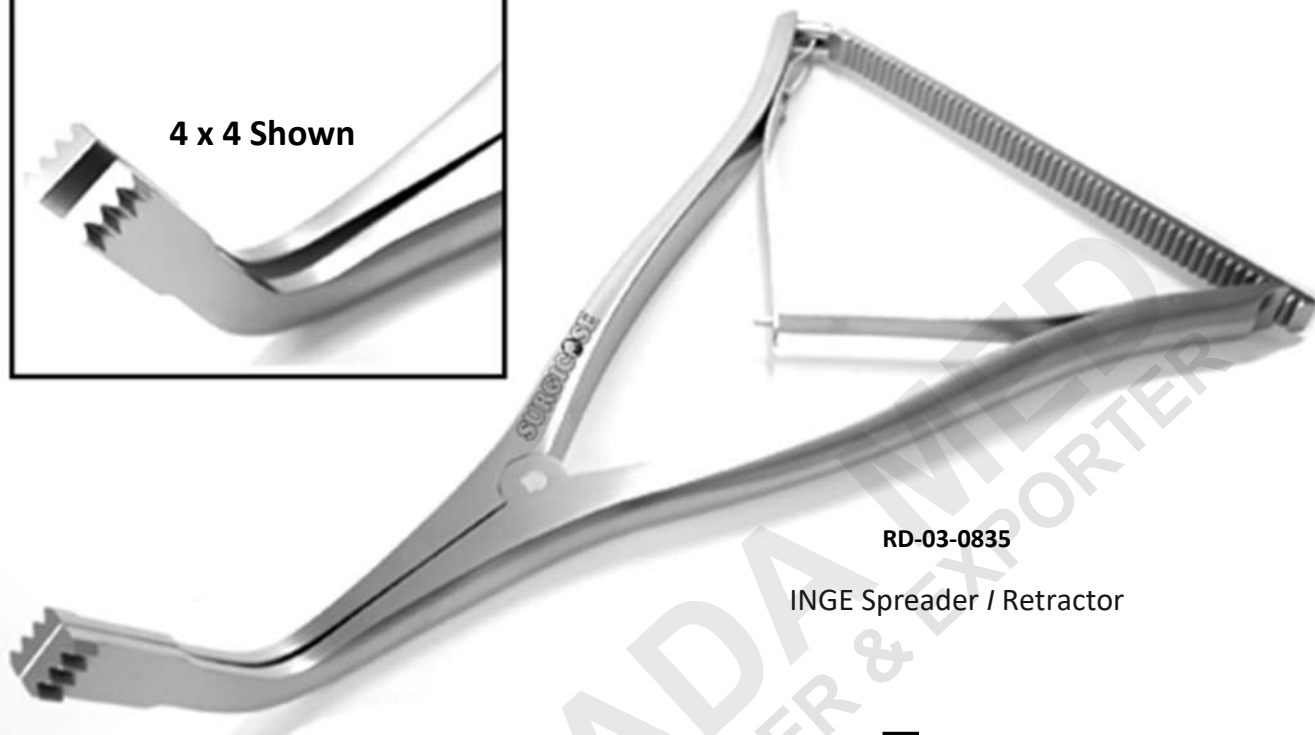

RD-03-0835

INGE Spreader / Retractor

Available in 4X4 and 6X6 Teeth
& Without Teeth (Plain)

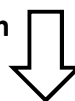

A: 4X4 Teeth
B: Without Teeth
16.5 cm / 6 1/2"



C: 4X4 Teeth
D: Without Teeth
25.5 cm / 10"



10 Inch Length Pattern

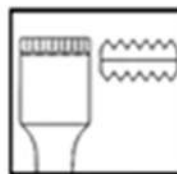

A: 6X6 Teeth
B: Without Teeth
27 cm / 10 1/2"
Flat Blades



C: 6X6 Teeth
D: Without Teeth
27 cm / 10 1/2"
Concave Blades



RD-03-0836-1

Offset Lamina Spreader / Retractor
25.5 cm / 10"

LAMINA SPREADERS - RETRACTORS

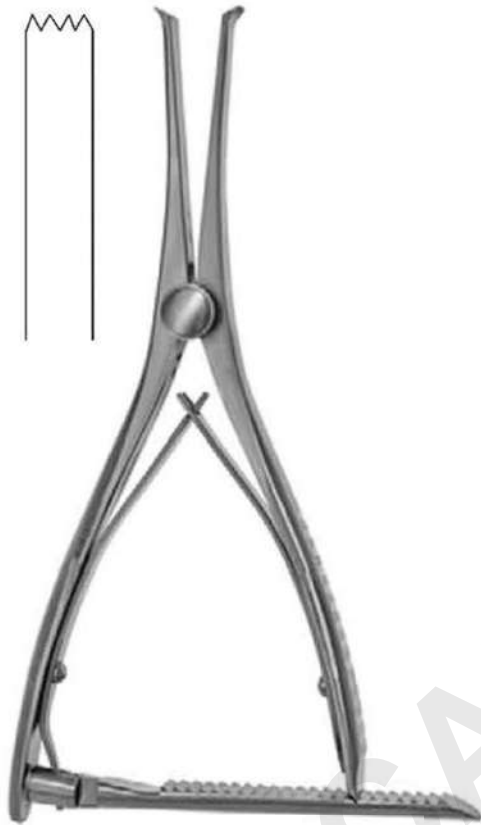
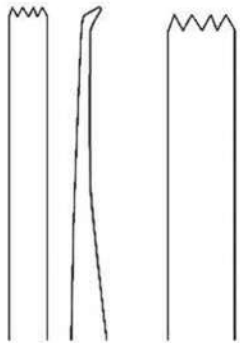

RD-03-0836-2
Vertibra Spreader / Retractor
A: 18 cm / 7" | B: 28 cm / 11"

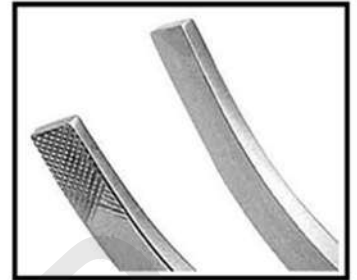

RD-03-0837
Inge Spreader
Serrated Outside Blades 18 cm / 7"



RD-03-0838

Saxsena Lamina Spreader / Retractor
A: 18 cm / 7" | B: 25.5 cm / 10"
Serrated Outside Blades

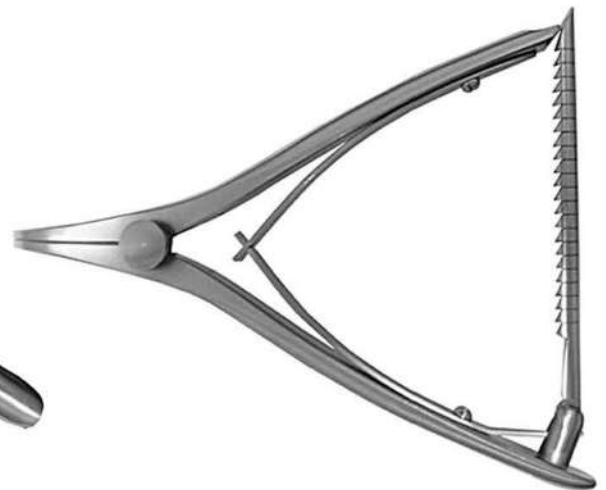

CALCANEAL - LAMBARDI SPREADERS



RD-03-0839
Calcaneal Spreader
Smooth Pads 15X12mm
18 cm / 7"



RD-03-0840
Calcaneal Spreader
Grooved Pads 15X12mm
18 cm / 7"



RD-03-0841
Lombardi Femoral Tibial Spreader (Small)
A: Grooved Pads 22X13mm 18 cm / 7"
B: Diamond Cut Pads 22x13mm / 7"



B: Diamond Cut Pads 22X13mm



B: Diamond Cut Pads 22X13mm



RD-03-0842
Lombardi Femoral Tibial Spreader (Large)
A: Grooved Pads 22X13mm 23.5 cm / 9 1/4"
B: Diamond Cut Pads 22x13mm / 9 1/4"

COMPRESSORS - DISTRACTORS



RD-03-0843

Distracting Forceps 23 cm / 9"
Long Ratchet / Spiral Spring
For Screws and Rods

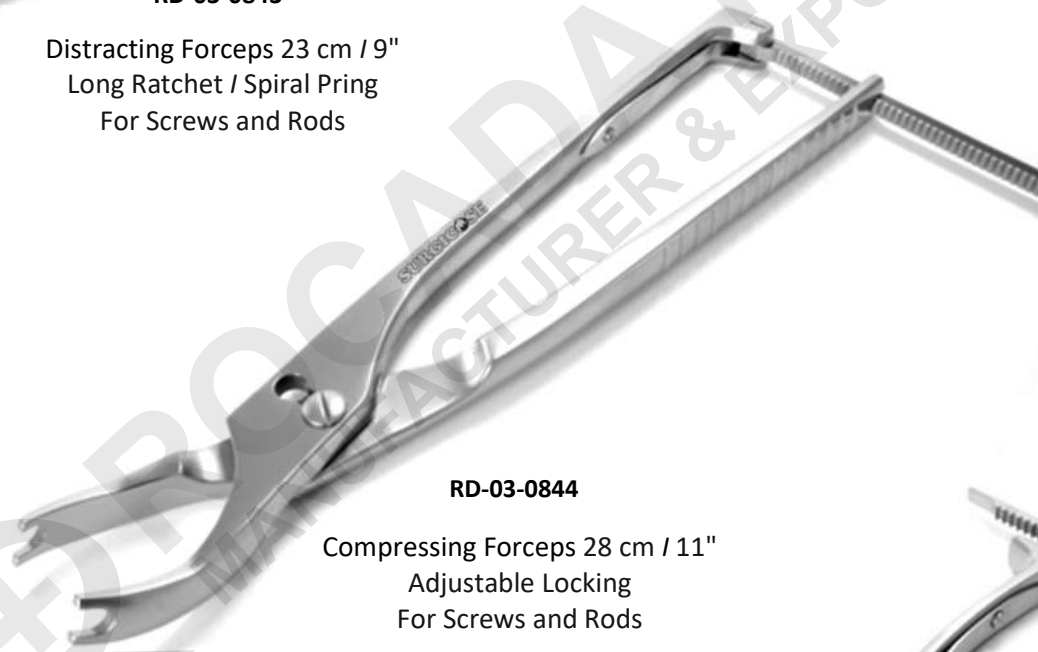

RD-03-0844

Compressing Forceps 28 cm / 11"
Adjustable Locking
For Screws and Rods

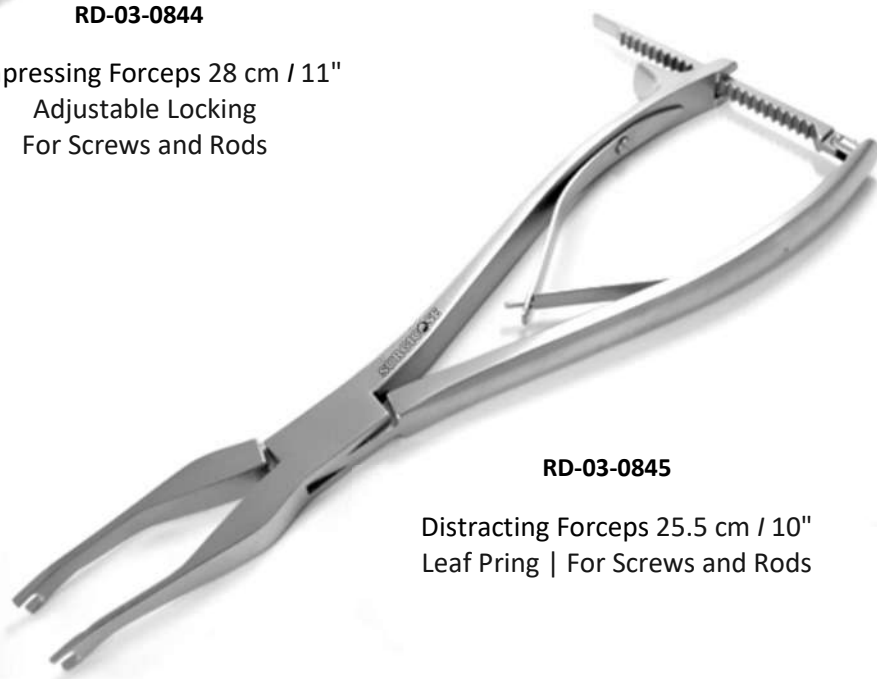

RD-03-0845

Distracting Forceps 25.5 cm / 10"
Leaf Spring | For Screws and Rods

COMPRESSORS - DISTRACTORS



RD-03-0846

Distractor 25.5 cm / 10"
Leaf Pring | For Screws and Rods



RD-03-0847

Compression Forceps
28 cm / 11"
Leaf Pring / Long Ratchet
For Screws and Rods

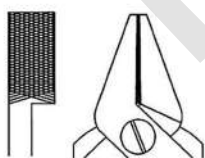

Non TC



RD-03-0848

Jet Wire Twisting Device
28 cm / 11" - 10mm Tip

ROD BENDERS

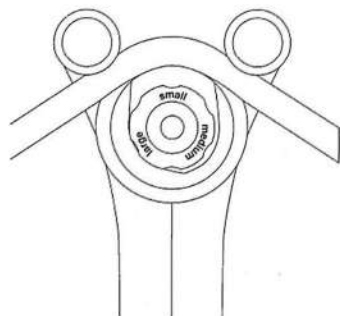

RD-03-0849

French Style Rod Bender
28 cm / 11" | Roller Type
For Small / Medium / Large Bends

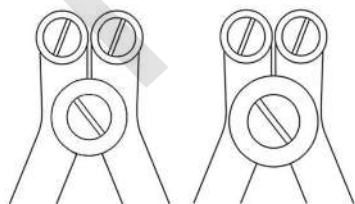
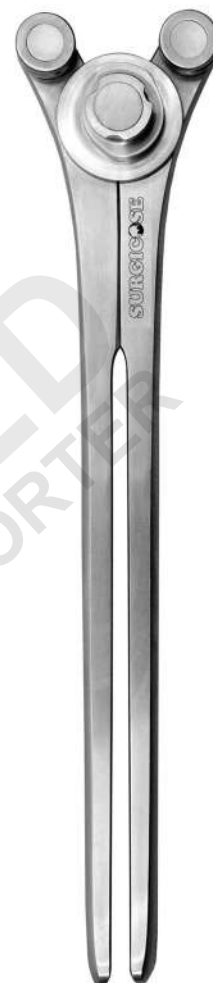

For 4mm Rod

For 3mm Rod



RD-03-0850

One Hand Rod Bender | 19 cm / 7"
For 3 and 4 mm Diameter Rod

CARBIDE INSERTED WIRE – PIN CUTTING PLIERS

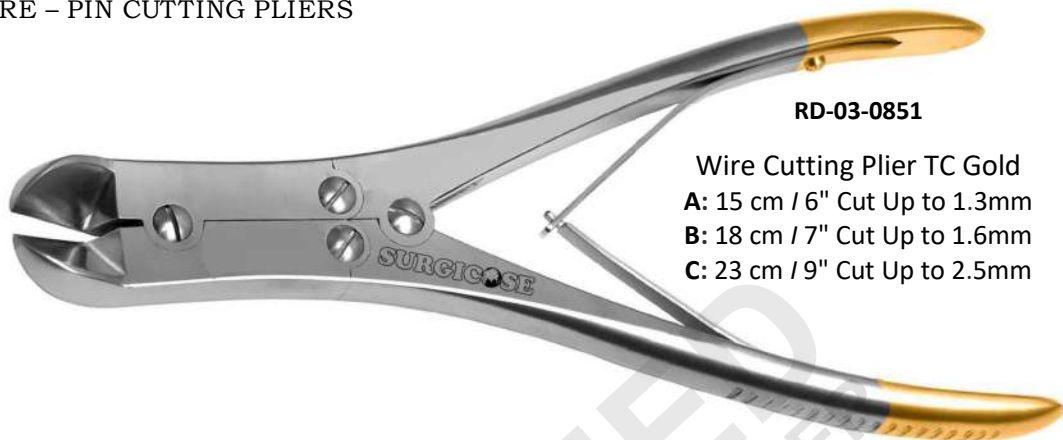
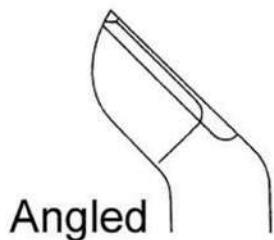

RD-03-0851

Wire Cutting Plier TC Gold
A: 15 cm / 6" Cut Up to 1.3mm
B: 18 cm / 7" Cut Up to 1.6mm
C: 23 cm / 9" Cut Up to 2.5mm



RD-03-0852

Wire Cutting Plier TC Gold
A: 15 cm / 6" Cut Up to 1.3mm
B: 18 cm / 7" Cut Up to 1.6mm



RD-03-0853

Wire Cutting Plier TC Gold
 23 cm / 9" Cut Up to 2.5mm



RD-03-0854

Wire Cutting Plier TC Gold
 18 cm / 7" Cut Up to 1.6mm

CARBIDE INSERTED WIRE – PIN CUTTING PLIERS



RD-03-0855

Cannulated Pin Cutter TC Gold
18 cm / 7" Cut Up to 1.5mm



RD-03-0856

Front End Wire Cutting Plier
TC Gold 15 cm / 6"
Cut Up to 1.3mm



RD-03-0857

Front End Wire Cutting Plier
TC Gold 23 cm / 9"
Cut Up to 2.5mm



RD-03-0858

Front End Wire Cutting Plier
TC Gold 23 cm / 9"
Cut Up to 2.5mm

CARBIDE INSERTED WIRE – PIN CUTTING PLIERS

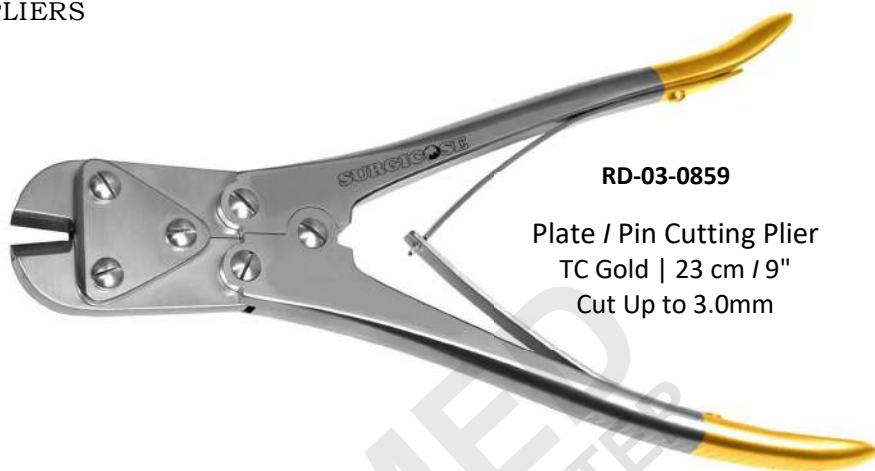

RD-03-0859

Plate / Pin Cutting Plier
TC Gold | 23 cm / 9"
Cut Up to 3.0mm



RD-03-0860

Pin / Wire Cutting Plier
TC Gold / Adjustable
23 cm / 9"
Cut Up to 2.5mm



RD-03-0861

Pin / Wire Cutting Plier
TC Gold | 23 cm / 9"
Cut Up to 2.5mm

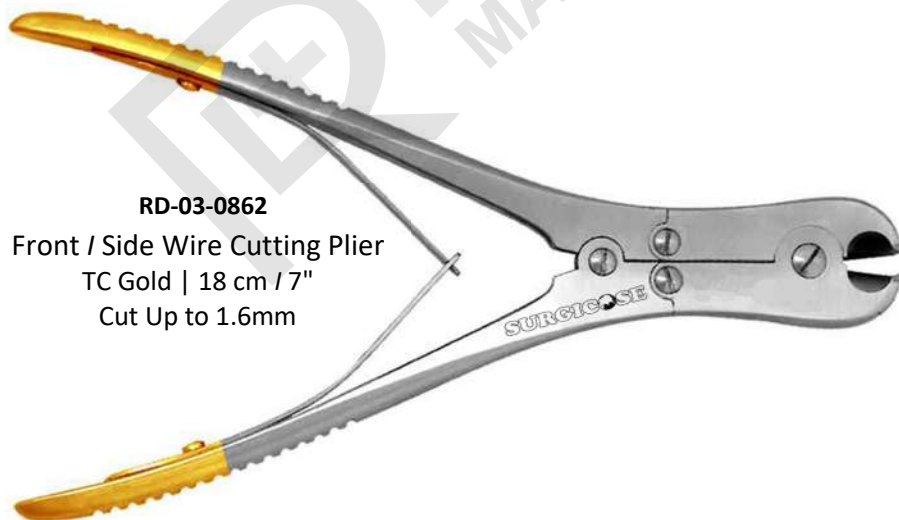

RD-03-0862

Front / Side Wire Cutting Plier
TC Gold | 18 cm / 7"
Cut Up to 1.6mm

CARBIDE INSERTED WIRE – PIN CUTTING PLIERS

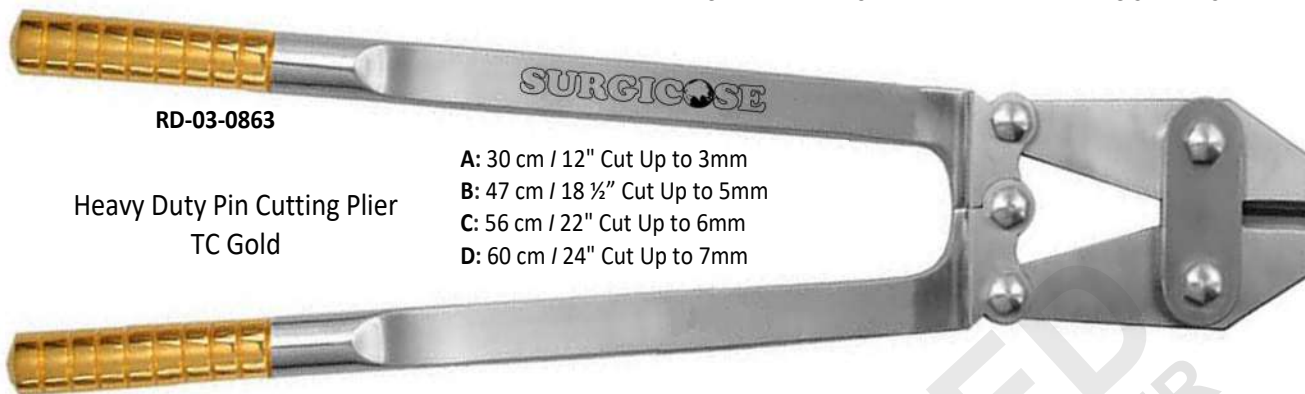

RD-03-0863

Heavy Duty Pin Cutting Plier
TC Gold

- A: 30 cm / 12" Cut Up to 3mm
- B: 47 cm / 18 ½" Cut Up to 5mm
- C: 56 cm / 22" Cut Up to 6mm
- D: 60 cm / 24" Cut Up to 7mm



RD-03-0864

Heavy Duty Pin End Cutting Plier TC Gold

- A: 27 cm / 10 ½" Cut Up to 3mm
- B: 38 cm / 15" Cut Up to 4mm

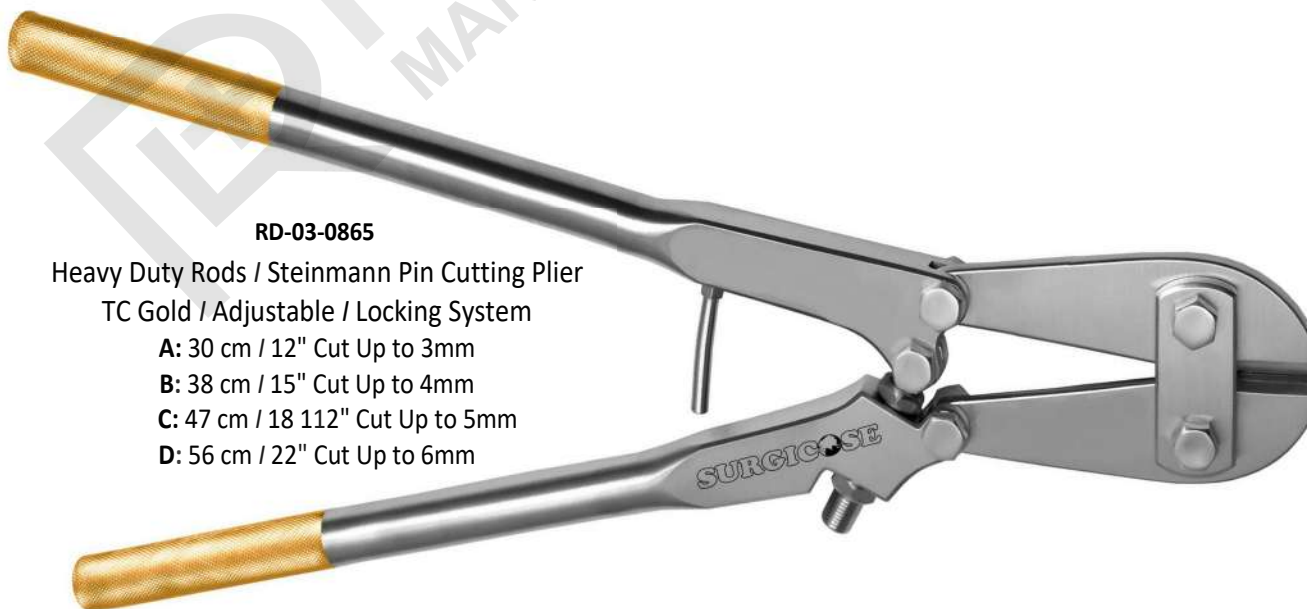

RD-03-0865

Heavy Duty Rods / Steinmann Pin Cutting Plier
TC Gold / Adjustable / Locking System

- A: 30 cm / 12" Cut Up to 3mm
- B: 38 cm / 15" Cut Up to 4mm
- C: 47 cm / 18 1/2" Cut Up to 5mm
- D: 56 cm / 22" Cut Up to 6mm

CARBIDE INSERTED SURGICAL SCISSORS



RD-03-0866
Wire Twisting Forceps



RD-03-0867
Wire Twisting Forceps



RD-03-0868
Wire Twisting Forceps



RD-03-0869
Corwin Combi-Wire Twisting Forceps 18.5 cm / 7 1/4"



RD-03-0870
Wire Twisting Forceps
15.5 cm / 6"



RD-03-0871
Wire Twisting Forceps
16 cm / 6 1/4"





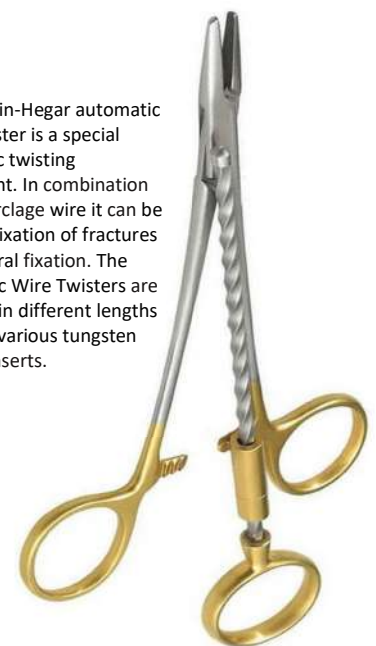



RD-03-0872
Wire Twisting Forceps
Heavy Pattern
19 cm / 7 1/2"

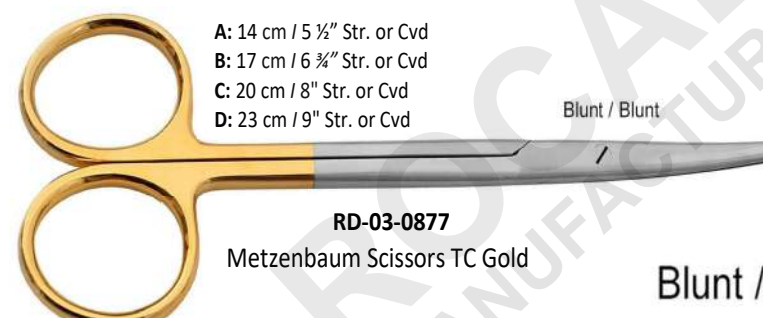

RD-03-0873
Corwin-Hegar
Auto Wire Twisting Forceps
15 cm / 6"

The Corwin-Hegar automatic Wire Twister is a special automatic twisting Instrument. In combination with a cerclage wire it can be used for fixation of fractures or temporal fixation. The Automatic Wire Twisters are available in different lengths and with various tungsten carbide inserts.

CARBIDE INSERTED SURGICAL SCISSORS

 <p>Sharp / Sharp Cvd or Str</p> <p>Blunt / Blunt Cvd or Str</p> <p>Sharp / Blunt Cvd or Str</p> <p>RD-03-0875 Operating (Standard) Scissors TC Gold</p> <p>A: 13 cm / 5" Str. or Cvd B: 14 cm / 5 1/2" Str. or Cvd C: 15.5 cm / 6 1/2" Str. or Cvd D: 18 cm / 7" Str. or Cvd</p>	<p>Blunt / Blunt</p> <p>A: 14.5 cm / 5 3/4" Str or Cvd B: 17 cm / 6 3/4" Str or Cvd C: 23 cm / 9" Str or Cvd</p> <p>RD-03-0874 Mayo Scissors TC Gold</p> 
 <p>A: 14 cm / 5 1/2" Str. or Cvd B: 17 cm / 6 3/4" Str. or Cvd C: 20 cm / 8" Str. or Cvd D: 23 cm / 9" Str. or Cvd</p> <p>RD-03-0877 Metzenbaum Scissors TC Gold</p>	<p>Blunt / Blunt</p> <p>A: 14.5 cm / 5 3/4" Str. or Cvd. B: 17 cm / 6 3/4" Str. or Cvd. C: 23 cm / 9" Str. or Cvd.</p> <p>RD-03-0876 Mayo Stille Scissors TC Gold</p> 
 <p>RD-03-0879 Ortho Universal Scissors TC Gold 12 cm / 4 1/3"</p>	<p>Blunt / Blunt</p> <p>A: 20 cm / 8" Str. or Cvd B: 23 cm / 9" Str. or Cvd C: 28 cm / 11" Str. or Cvd D: 30 cm / 12" Str. or Cvd</p> <p>RD-03-0878 Mayo-Harrington Scissors TC Gold</p> 
	<p>RD-03-0880 Mayo-Nobel Scissors TC Gold 16.5 cm / 6 1/2" Str. or Cvd</p> 

INSTRUMENTS FOR TRUAMATOLOGY



Drill Bits for Quick Coupling

Drill bit 1.1mm dia.
for threaded hole for 1.5mm screws

Drill bit 1.5mm dia.

For threaded hole for 2.0mm screws and gliding hole for 1.5mm
Screws

Drill bit 2.0mm dia.

For threaded hole for 2.7mm dia.

For gliding hole for 2.7mm screws

Item	Diameter	Total length	Usable length
100.001	1.1mm	060mm	035mm
100.002	1.5mm	085mm	060mm
100.003	1.5mm	110mm	085mm
100.004	2.0mm	100mm	145mm
100.005	2.0mm	125mm	100mm
100.006	2.7mm	100mm	075mm
100.007	2.7mm	125mm	100mm
100.008	2.7mm	100mm	075mm
100.009	2.0mm	125mm	100mm

Drill bit 2.5mm dia.

For threaded hole for 3.5 and 4.0mm screws

Drill bit 3.5mm

for gliding hole for 3.5mm screws

Item	Diameter	Total length	Usable length
100.010	2.5mm	110mm	085mm
100.011	2.5mm	180mm	155mm
100.012	3.5mm	100mm	085mm
100.013	3.5mm	195mm	170mm

Drill bit 3.2mm dia.

For threaded hole for 4.5 and 6.5mm screws

Drill bit 4.0mm dia.

For gliding hole for 4.5mm screws

Item	Diameter	Total length	Usable length
100.014	2.0mm	100mm	145mm
100.015	3.2mm	225mm	200mm
100.016	3.2mm	145mm	120mm
100.017	3.2mm	195mm	170mm
100.018	4.5mm	145mm	120mm
100.019	4.5mm	195mm	170mm



Drill Bit for Jacobs chuck

Item	Diameter	Total length	Usable length
101.001	1.1mm	45mm	30mm
101.002	1.5mm	70mm	55mm
101.003	2.0mm	85mm	70mm
101.004	2.5mm	95mm	80mm
101.005	2.7mm	85mm	70mm
101.006	3.2mm	130mm	115mm
101.007	3.2mm	180mm	165mm
101.008	3.5mm	95mm	80mm
101.009	3.5mm	180mm	165mm
101.010	4.5mm	130mm	115mm
101.011	4.5mm	180mm	165mm



RD-03-0881

Tap for 1.5mm Cortex Screws

Total length 50mm, thread length 20mm
predrilling 1.1mm dia.



RD-03-0882

Tap for 6.5mm Cancellous Bone Screws

Length 195mm, predrilling 3.2mm dia.



RD-03-0883

Tap for 4.0mm Cancellous Bone Screws

Total Length 110mm, Usable Length 85mm



RD-03-0884

Tap Cannulated, for 7.0mm Cannulated Screws

Length 230mm

INSTRUMENTS FOR TRUAMATOLOGY



Tap for 3.5mm Cortex Screws
Predrilling: 2.5mm dia.

Item	Total length	Type
102.007	175mm	with length markings
102.008	110mm	thread length 50mm

Tap for 2.0mm Cortex Screws
Predrilling: 1.5mm dia.

Tap for 2.7mm Cortex Screws
Predrilling: 2.0mm dia.

Item	Thread	length
102.001	24mm	053mm
102.002	38mm	100mm

Item	Thread length	Total length
102.005	33mm	100mm
102.006	40mm	150mm

Predrilling: 3.2mm

Item	Length	Type
102.003	125mm	thread length 70mm
102.004	175mm	with length markings

102.009

Tap for 3.5mm Cortex Screws
Total Length: 110mm
Thread Length: 50mm
Predrilling: 3.2mm dia.

102.010

Tap for 2.7mm Cortex Screws
Total length: 125mm
Thread length: 40mm
Predrilling: 2.0mm dia.

102.011

Tap for 4.5mm Cortex Screws
Total length: 125mm
Thread length: 70mm
Predrilling: 3.2mm dia.



RD-03-0885
Countersink Shaft 1.5/2.0
Length 52mm, for mini quick coupling



RD-03-0886
Router, for Jacobs chuck
Length 90mm



RD-03-0887
Router, for quick coupling
Length 90mm



RD-03-0888
Countersink Shaft 3.5mm
Length 72mm, for quick coupling,
to countersink the screw head

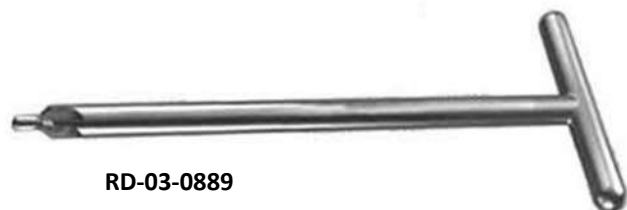

RD-03-0889
Countersink, large
Length 180mm, for 4.5mm cortex screws



RD-03-0890
Dountersink, cannulated, for 7.0mm cannulated Screws
Length 230mm

INSTRUMENTS FOR TRUAMATOLOGY



RD-03-0891

Screwdriver Shaft, hexagonal, small
Length 100mm, for quick coupling
For 2.7 to 4.0mm screws.



RD-03-0892

Screwdriver Shaft, Hexagonal, large
Length 100mm, final tightening of the screw has to be done by hand.



RD-03-0893

Screwdriver Shaft, hexagonal, with Holding Sleeve
For 1.5 and 2.0mm stainless steel screws
With hexagonal socket,



RD-03-0894

Screwdriver Shaft, cruciform, 1.5/ 2.0, with Holding Sleeve
Length 50mm, for 1.5 and 2.0mm

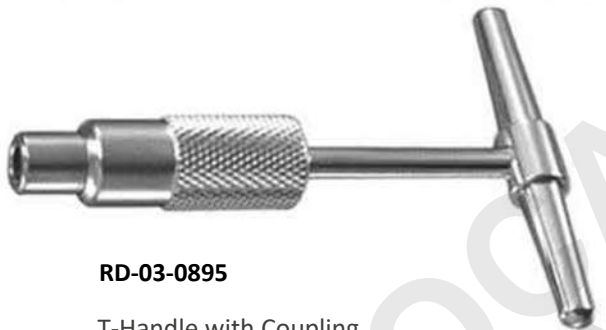

RD-03-0895

T-Handle with Coupling
Length: 80mm, for taps



RD-03-0896

Screwdriver, hexagonal, with T-Handle,
Large to loosen tight screws.
A normal screwdriver can be additionally inserted in the hollow shaft of the T-handle.



RD-03-0897

Handle with mini quick coupling



RD-03-0898

Hand Chuck for Kirschner Wires
Length 145mm, Spannbereich 0.6 to 1.6mm dia.



RD-03-0899

Handle with quick coupling
Length 110mm, for countersinks and Instruments for the removal of damaged screws



RD-03-0900

Handle, small, with mini quick coupling

INSTRUMENTS FOR TRUAMATOLOGY



RD-03-0901
Handle, medium, with mini quick coupling



RD-03-0902
Handle, Large, with mini quick coupling



RD-03-0903
Screwdriver, hexagonal, small with groove
Length 200mm, for 2.7 to 4.0mm screws



RD-03-0904
Screwdriver with Universal Joint, large
Length 290mm



RD-03-0905
Screwdriver, hexagonal, large, with groove
Length 240mm



RD-03-0906
Screwdriver, hexagonal, with Holding Sleeve,
Length 165mm for 1.5 and 2.0mm stainless
Steel screws with hexagonal socket



RD-03-0907
Screwdriver, hexagonal, small, with Holding Sleeve
Length 200mm



RD-03-0908
Holding Sleeve for Mini Screws single



RD-03-0909
Holding Sleeve



RD-03-0910
Allen Key, hexagonal, angled
For 4.5 to 7.0mm screws



RD-03-0911
Holding Sleeve single

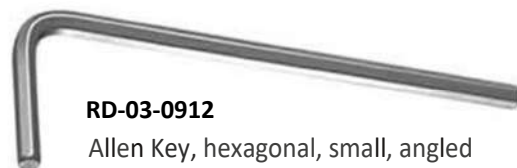

RD-03-0912
Allen Key, hexagonal, small, angled
Length 65mm, for 2.7 to 4.0mm screws

INSTRUMENTS FOR TRUAMATOLOGY



RD-03-0913

Insert Drill Sleeve 3.5/2.5
Length 42mm, drill bit 2.5mm dia.



RD-03-0914

Insert Drill Sleeve 4.5/3.2
Length 80mm for long lag screws



RD-03-0915

Trocar 2.0mm dia., Length 118mm, for percutaneous insertion of 7.0mm cannulated screws



RD-03-0916

Drill Sleeve 8.0/4.5
Length 100mm, for percutaneous insertion of 7.0mm cannulated screws



RD-03-0917

Drill Sleeve 4.5/ 2.0
Length 109mm, for percutaneous insertion of 7.0mm cannulated screws



RD-03-0918

Handle for Drill Guides single



RD-03-0919

Handle for Drill Guides single



RD-03-0920

Drill Sleeve 3.0 with point length 55mm

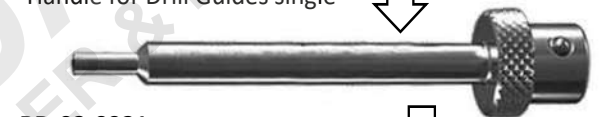

RD-03-0921

Drill Sleeve 1.5mm / 2.0 / 2.7mm



RD-03-0922

Drill Sleeve 2.7



RD-03-0923

Double Drill Sleeve 1.5/101
For 1.5mm cortex screws
Drill bits, 1.5 and 1.1mm dia.



RD-03-0924

Double Drill Sleeve 2.0/1.5 for
2.7mm cortex screw



RD-03-0925

Double Drill Sleeve 2.7/2.0
For 2.7mm cortex screws



RD-03-0926

Double Drill Sleeve 3.5/2.5
For 3.5mm cortex screws and 4.0mm cancellous bone screws
Drill bits 3.5 and 2.5 dia.,

INSTRUMENTS FOR TRUAMATOLOGY



RD-03-0927
Double Drill Sleeve 4.5/3.2
For 4.5mm cortex screws
Drill bits: 4.5 and 3.2mm dia.



RD-03-0928
Double Drill Sleeve 6.5/3.2
For 6.5mm cancellous bone screws
Drill bit: 3.2mm dia.



RD-03-0929
Universal Drill Sleeve 2.7
Drill bits 2.0 and 2.7mm dia.,
Suitable for LC-DCP and round hole plates.



RD-03-0930
Universal Drill Guide 3.5
Drill bit 2.5 and 3.5mm dia., and tissue protection
Suitable for LC-DCP and round hole plates.



RD-03-0931
Universal Drill Guide 4.5/3.2
Drill bits 3.2 and 4.5mm dia.



RD-03-0932
DCP Drill Guide 2.0
For neutral and load position
Drill bit 1.5mm dia.



RD-03-0933
DCP Drill Guide 2.7
For neutral and load position
Drill bit 2.0mm dia.



RD-03-0934
DCP Drill Guide 3.5
For neutral a load position, drill bit 2.5m dia.

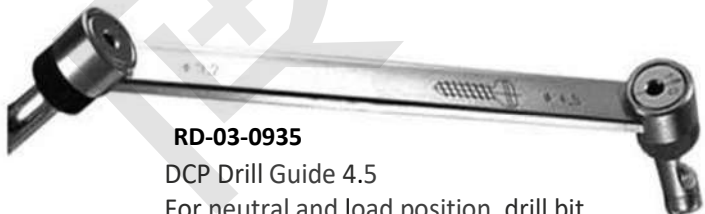

RD-03-0935
DCP Drill Guide 4.5
For neutral and load position, drill bit 3.2mm dia.



RD-03-0936
LC-DCP Drill Guide 3.5
For neutral a load position, drill bit 2.5mm dia.



RD-03-0937
LC-DCP Drill Guide 4.5
For neutral and load position, drill bit 3.2mm dia.



RD-03-0938
DCP Hip Drill Guide 4.5, for neutral and load position, for 4.5mm screws with DHS and angled blade plates, sleeve length 60mm, drill bit 3.2mm dia.

INSTRUMENTS FOR TRUAMATOLOGY



RD-03-0939
Triple Drill Sleeve 2.0
with 3 holes, opposite side 1 hole

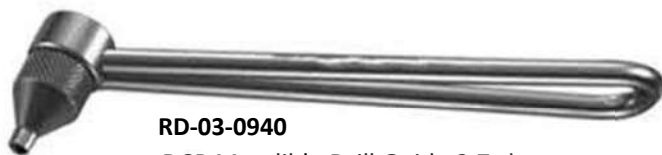

RD-03-0940
DCP Mandible Drill Guide 2.7 short
drill bit 2.0mm dia.



RD-03-0941
DCP Mandible Drill Guide 2.7 long
drill bit 2.0mm dia.



RD-03-0942
Insert Drill Sleeve with stop, for 4.5mm screws
adjustable length to limit drilling depth,
external dia. 4.5mm for drill bits of 3.2mm dia.



RD-03-0943
Parallel drill Guide 4.5
For percutaneous insertion of 7.0mm cannulated screws



RD-03-0944
Parallel Wire Guide 2.0mm dia.



RD-03-0945
Depth Gauge for 2.7 to 4.0m screws
measuring range up to 60mm



RD-03-0947
Depth Gauge for 2.7 to 4.0mm screws measuring
range up to 60mm



RD-03-0948
Depth Gauge for 4.5mm to 6.5mm screws measuring
range up to 110mm



RD-03-0946
Bending Iron for plates 2.7 and 3.5
Length 150mm, slid widths 2.5 and 4.5mm, required paris
Slid placement: 4.5 / 2.5
Slid placement: 2.5/4.5



RD-03-0949-1
Bending Iron for plates 1.5 and 2.5
Length: 130mm, slid width: 2.5mm

INSTRUMENTS FOR TRUAMATOLOGY

RD-03-0949-2

Triple Drill Guide
130° angle, for 130° angled blade plates and
for condylar plates, drill bit 4.5mm dia.



RD-03-0950

Drill Guide with stop 3.5/2.7
to limit drilling depth



RD-03-0951

Protection Sleeve 11.0/8.0
for percutaneous insertion of 7.0mm
cannulated screws



RD-03-0952

Holding Sleeve
Length 80mm, for 2.7 to 4.0mm screws



RD-03-0953

Holding Sleeve for length 80mm for 2.7mm screws
and 3.5mm cannulated screws



RD-03-0954

Holding Sleeve, large, length 120mm

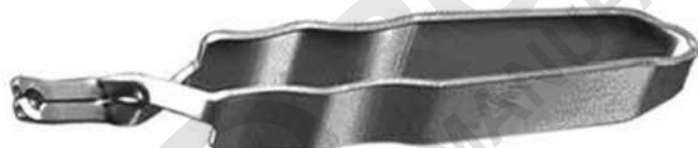

RD-03-0955

Screw Forceps, self-holding
Length 85mm, to take screws out of the screw racks



RD-03-0956

Drill Sleeve, pointed



RD-03-0957

Bending Iron LC-DCP/DCP
Length 250mm, for small and broad LC-DCP, DCP
Slit widths 5 and 7mm, required in pairs

INSTRUMENTS FOR TRUAMATOLOGY



RD-03-0958
Bending Iron for Kirschner Wires
Length 120mm, for 1.25 to 2.5mm dia.



RD-03-0959
Bending Iron for Kirschner Wires
Length 115mm, for 0.8 to 1.25mm dia.



RD-03-0960
Bending Iron for Reconstruction Plates 3.5 and 4.5
Length 190mm, required in paris



RD-03-0961
Handle with Sleeve
with rotating drill guide and anchoring point



RD-03-0962
Trocar Point, large



RD-03-0963
Combination Wrench 11mm length 140mm



RD-03-0964
Cheek Retractor Ring



RD-03-0965
Pin Wrench, length 120mm, 4.5mm dia.
For tension device, distractor and knurled
nut of insertion handle for intramedullary nail

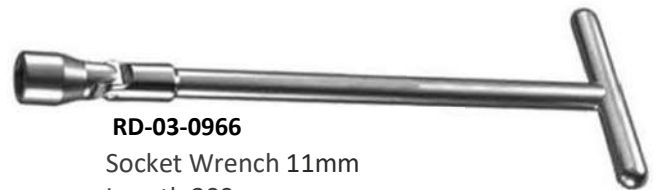

RD-03-0966
Socket Wrench 11mm
Length 200mm



RD-03-0967
Slotted Hammer
Length 270mm



RD-03-0968
Inserter/Extractor, with Adjustable Clamps, length 270mm, for the
insertion and extraction of angled plates for adults and hip plates for
adolescents and children as well as tibial plateau osteotomy plates.



RD-03-0969
Measuring Device
For drill bits, screws, Kirschner wires,
and Steinmann pins

INSTRUMENTS FOR TRUAMATOLOGY



RD-03-0970

Inserter/Extractor
Length 175mm, for infant hip plate and mini hip plate.



RD-03-0971

Bending Pliers for Reconstruction Plates 2.7 and 3.5
Length 240mm



RD-03-0972

Bending Pliers for plate 2.4 to 4.0
Length 230mm



RD-03-0973

Cutter for thin plates 1.5 to 2.7
Length 256mm



RD-03-0974

Bending Pliers
For reconstruction plates 2.7,
Length 270mm, required in paris



RD-03-0975

Cerclage Wire Tightener
Length 260mm
For twisting, for temporary fixation during reduction



RD-03-0976

Bending Pliers for Plates

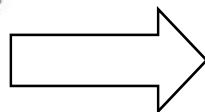

RD-03-0977
Anvil, narrow



RD-03-0978
Anvil, Large

INSTRUMENTS FOR TRUAMATOLOGY

RD-03-0979

Bending Press
Length 400mm



RD-03-0980

Tension Device, articulated
Span 20mm, can also be used as a distractor.
Color scale: yellow up to 500N, green up to 1000N,
red above 100N.



RD-03-0981

Chisel Guide
With adjustable angle



RD-03-0982

Blade with foot single



RD-03-0983

Blade with tip single

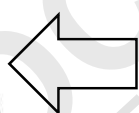
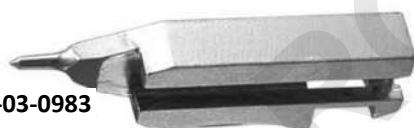

RD-03-0984

Forceps with Sliding Blades
Complete with two interchangeable blades
Length 155mm, weight 42 g, speed lock

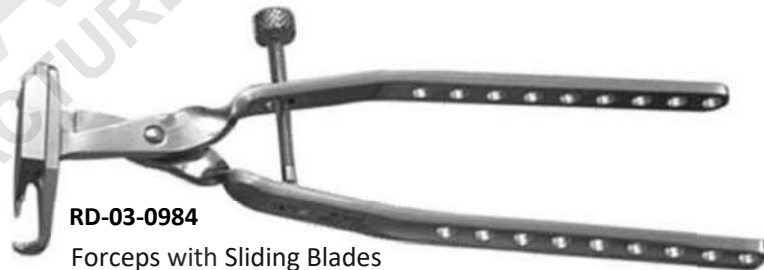

RD-03-0985

Wire Passer 45mm bending diameter



RD-03-0986

Wire Passer 70mm bending diameter



RD-03-0987

Holding Clip



RD-03-0988

Wire Tightener
Length 240mm, with handle and two pegs



INSTRUMENTS FOR TRUAMATOLOGY



RD-03-0989
Handle with quick coupling
Length 150 mm



RD-03-0990
Cancellous Bone Impactor, curved, 6mm dia.
Length 140 mm



RD-03-0991
Cancellous Bone Impactor, curved, 6mm dia.
Flattened, Length 140 mm



RD-03-0992
Cancellous Bone Impactor, straight, 8 mm dia.
Length 140 mm



RD-03-0993
Cancellous Bone Impactor, rectangular,
6x16mm, Length 140 mm



RD-03-0994
Cancellous Bone Impactor, rectangular,
10x20mm, Length 140mm

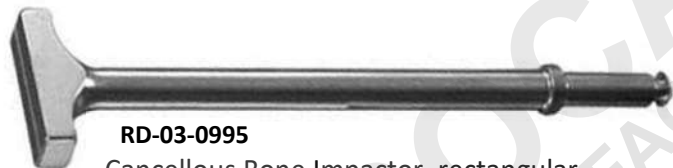

RD-03-0995
Cancellous Bone Impactor, rectangular,
10x30mm, Length 140 mm



RD-03-0996
Rasp round
Length: 140 mm



RD-03-0997
Rasp, half-round
Length: 140 mm



RD-03-0998
Gouge, straight, 5mm wide
Length 140 mm



RD-03-0999
Gouge, curved, 5mm wide
Length 140 mm



RD-03-1000
Gouge, straight, 10 mm wide
Length 140mm



RD-03-1001
Gouge, curved, 10 mm wide
Length 140 mm



RD-03-1002
Gouge, curved, 15 mm wide
Length 140 mm

INSTRUMENTS FOR TRUAMATOLOGY



RD-03-1003
Gouge, straight, 15 mm wide
Length 140 mm



RD-03-1004
Chisel, flat, curved, 16 mm wide
Length 140 mm



RD-03-1005
Chisel, flat, straight, 16 mm wide
Length 140 mm



RD-03-1006
Chisel, flat, curved, 4 mm wide
Length 140 mm



RD-03-1007
Chisel, flat, 20 mm wide
Length 140 mm



RD-03-1008
Chisel, flat, curved, 8 mm wide
Length 140 mm

GET IN TOUCH



Email : info@rocadamed.net



Website: www.rocadamed.net



Mobile & Whatsapp: **00923461330105**



Sialkot, 51310, Pakistan